



INSTRUCTION MANUAL

VHF/UHF
ALL MODE TRANSCEIVER
IC-820H



1 PANEL DESCRIPTION

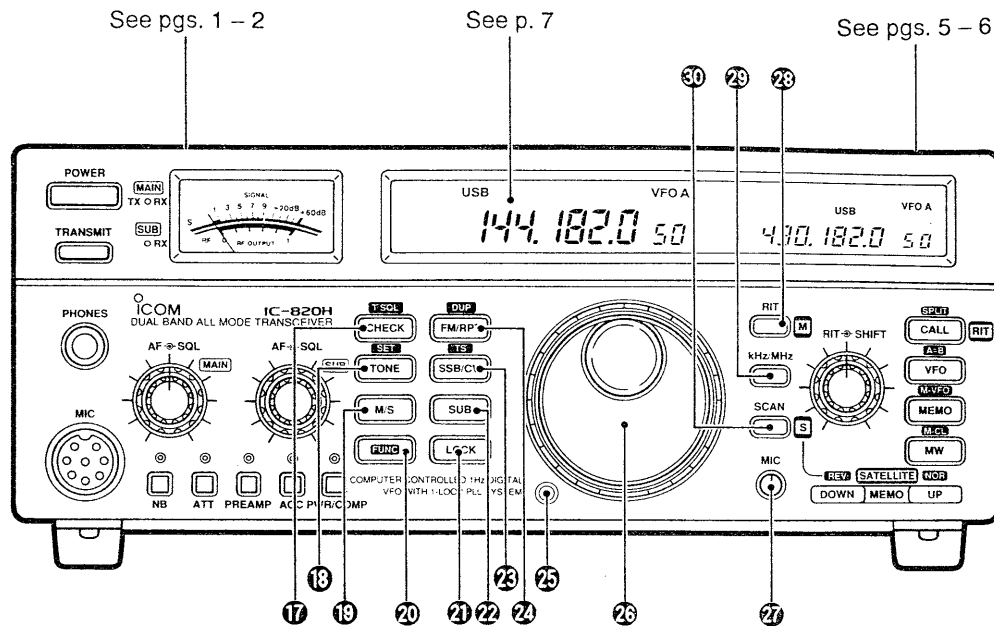

17 FREQUENCY CHECK SWITCH [CHECK·T SOL] (pgs. 23, 25)

- CHECK** • Opens the squelch manually to check the operating frequency condition.
 - Checks the transmit frequency simultaneously when selecting duplex or split operation.
- FUNC** • Activates an optional tone squelch function for rejecting undesired signal reception.
 - Both the main and sub bands can be used with an optional UT-50 TONE SQUELCH UNIT, however, if you want to use the tone squelch on both bands simultaneously, two UT-50's are necessary.

18 TONE SWITCH [TONE·SET] (p. 25)

- TONE** • Turns the subaudible tone encoder ON and OFF (U.S.A. and Australia versions).
 - Transmits a 1750 Hz tone call signal when pushed (Europe and Sweden versions).
- FUNC** then **SET** then **TONE** • Enters the set mode after pushing [FUNC] for selection of the following:

Rotate the tuning dial to change the contents when a display appears.

Po C-OFF	[PWR/COMP] switch function.
DUP - o-touch	Shift direction for the one touch repeater function.
DUP - 0.600	Offset frequency
T 88.5	Subaudible tone frequency
T-SQL 88.5	Tone squelch frequency (Appears only when an optional UT-50 is installed.)

19 MAIN/SUB EXCHANGE SWITCH [M/S] (p. 19)

Replaces the main band's frequency and mode with the sub band's.

20 FUNCTION SWITCH [FUNC]

- FUNC** • Activates the secondary function of some switches.
- FUNC** + **POWER** • Enters the F-set mode when pushed at power ON. (p. 39)
- FUNC** Push and hold • Displays the frequency readout below the 10 Hz-digits when pushed and held. (p. 21)
 - The memory channel readout appears below the 10 Hz-digit while rotating the tuning dial and returns to channel number indication 1 sec. after tuning.

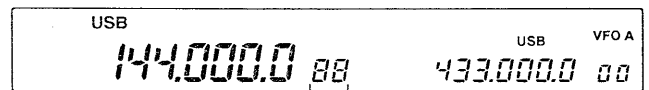

Changes to 10/1 Hz digit indicator while rotating the tuning dial.

21 DIAL LOCK SWITCH [LOCK] (pgs. 22, 23, 25)

- LOCK** • Turns the dial lock function ON and OFF.
 - The dial lock function electronically locks the tuning dial.
 - Announces the accessed band's frequency, mode, etc. when an optional UT-36 VOICE SYNTHESIZER UNIT is installed and dial lock function is turned ON.
- LOCK** + **POWER** • Enters the L-set mode when pushed at power ON. (p. 41)

22 SUB BAND SWITCH [SUB] (p. 19)

Activates the sub band access function to control the sub band's frequency/mode while standing by on the main band.

- "SUB" appears in the function display while the function is in use.

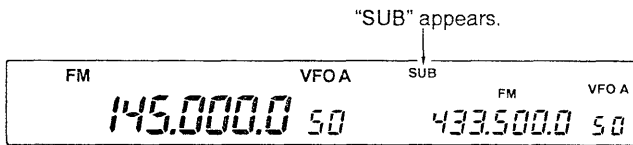

23 SSB/CW MODE SWITCH [SSB/CW-TS] (pgs. 17, 18)

[SSB/CW] • Selects USB, LSB, CW or CW-Narrow* mode in sequence.

* Selectable only when the main band is selected. When an optional CW narrow filter is not installed, no audio is output in CW-N.

[FUNC] then **[TS]** **[SSB/CW]** • Indicates accessed band's tuning step increments after pushing [FUNC]; use the tuning dial to change the tuning steps. (p. 21)

- Tuning steps can be separately selected for FM and SSB/CW.

FM : 0.1, 5, 10, 12.5, 20, 25, 100 kHz
SSB/CW : 1, 10, 50, 100 Hz

24 FM MODE SWITCH [FM/RPT-DUP] (pgs. 17, 27)

[FM/RPT] • Selects an FM mode.
- FM mode with a duplex/subaudible tone encoder setting is selected when pushing twice on the main band (U.S.A. and Australia versions).

[FUNC] then **[DUP]** **[FM/RPT]** • Selects -duplex, +duplex or cancel the duplex (simplex) on the main band in sequence after pushing [FUNC]. (p. 27)

- An auto-repeater function is available to activate duplex and the tone encoder automatically when in a repeater frequency range (U.S.A. and Australia versions).

25 BRAKE ADJUSTMENT SCREW

Adjusts the tuning dial tension.



26 TUNING DIAL (p. 21)

Changes the displayed frequency, etc.

Tuning rates (frequency change/rotation of tuning dial)

MODE	Selected tuning step	Normal rotation	Rapid rotation
SSB, CW	1 Hz	200 Hz	2 kHz
	10 Hz	2 kHz	20 kHz
FM	5 kHz	250 kHz	250 kHz

27 MIC GAIN CONTROL [MIC] (p. 25)

Adjusts microphone input gain.

- Adjust the [MIC] control so the [TX] indicator brightly illuminates (ALC activates) periodically during normal voice transmission.

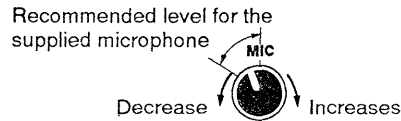

28 RIT SWITCH [RIT-M] (pgs. 23, 24)

[RIT] • Turns the RIT function ON and OFF.
- Use the [RIT] control to vary the RIT frequency.

[FUNC] then **[RIT]** • Activates the sub tuning dial function according to the L-set mode selection. (p. 22)

[RIT] **[M]** • Cancels the tracking function; the tuning dial changes the main band only, for Doppler shift compensation, while pushed in the satellite mode. (p. 34)

FUNCTION

The **RIT** (Receiver Incremental Tuning) shifts the receive frequency without shifting the transmit frequency.

This is useful for fine tuning stations calling you on an off-frequency or when you prefer to listen to slightly different-sounding voice characteristics, etc.

29 QUICK TUNING SWITCH [kHz/MHz] (p. 21)

• Selects the 1 kHz or a pre-selected normal tuning step.
• Selects the 1 MHz tuning step when pushed for 2 sec.

"▼" indicates the selected quick tuning step.

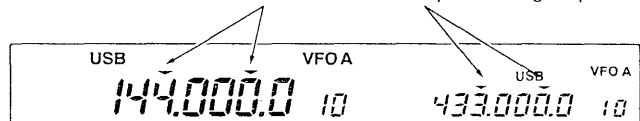

30 SCAN SWITCH [SCAN-S] (p. 37)

[SCAN] • Starts and stops the programmed scan, memory scan or mode select memory scan.

[SCAN] **[S]** • Cancels the tracking function; the tuning dial changes the sub band only while pushed in the satellite mode. (p. 34)

[FUNC] then **[SCAN]** • Starts the optional tone scan when the tone encoder or tone squelch is in use. (p. 28)

- An optional UT-50 is required.

1 PANEL DESCRIPTION

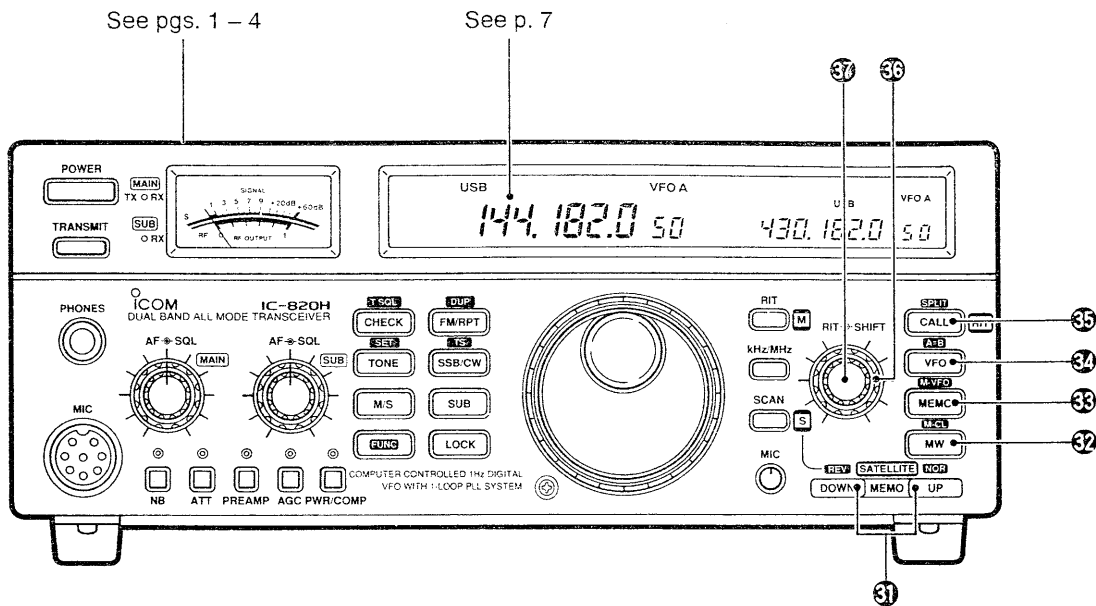

31 MEMORY UP/DOWN SWITCHES [MEMO DOWN/UP·SATellite REV/NOR] (pgs. 30, 34)

DOWN
OR
UP

- Select the memory channel number.
 - Memory channel can be selected both in the VFO and memory modes.

FUNC
then
REV
DOWN
OR
NOR
UP

- Enter the satellite mode after pushing [FUNC] to track the main and sub bands frequencies.
 - When selecting the satellite mode, the [VFO] switch selects the satellite VFO mode and the [MEMO] switch selects the satellite memory mode.

FUNC
then
REV
DOWN
OR
NOR
UP

- Exit the satellite mode after pushing [FUNC].
- Enter and exit the satellite mode using the current operating frequencies when pushing one of these for 2 sec. after pushing [FUNC].

FUNC then **REV**
DOWN

Indicates reverse tracking for the uplink and downlink frequencies.

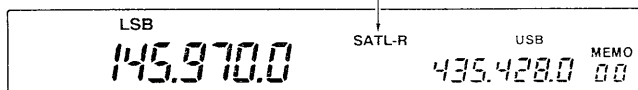

FUNC then **NOR**
UP

Indicates normal tracking for the uplink and downlink frequencies.

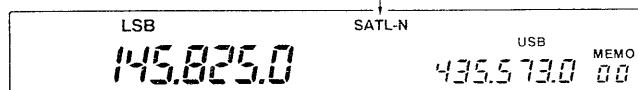

Uplink frequency

Downlink frequency

32 MEMORY WRITE SWITCH [MW·M-CL] (pgs. 30, 31)

MW
Push and hold

- Stores displayed frequency and mode into the displayed memory channel when pushed for 2 sec.
 - This function is available both in the VFO and memory modes.

FUNC
then
M-CL
MW
Push and hold

- Clears memory channel contents when pushed for 2 sec. after pushing [FUNC].
 - This switch does not function in the VFO mode.

33 MEMORY SWITCH [MEMO·M▶VFO] (pgs. 29, 31)

MEMO

- Selects the memory mode.
 - When the selected channel is not programmed, a selected band name (140 or 400) appears 2 sec. after the selection.

MEMO
+

- While pushed and held, the tuning dial changes the memory channel.

FUNC
then
M▶VFO
MEMO
Push and hold

- When pushed for 2 sec. after pushing [FUNC], transfers the programmed contents in the selected memory channel to a VFO.
 - This function is available both in the VFO and memory modes.

34 VFO SWITCH [VFO•A=B] (p. 20)

- VFO** • Selects VFO mode and toggles VFO A and B.
- FUNC** then **A=B** **VFO** • When pushed for 2 sec. after pushing [FUNC], equalizes the contents (frequency, operating mode, etc.) of the two VFO's.
 - The rear (undisplayed) VFO contents are equalized to the front (displayed) VFO contents.

35 CALL SWITCH [CALL•SPLIT] (pgs. 33, 26)

- Calls up the call channel.
- CALL** • Turns the RIT function ON and OFF while in the satellite mode.
- FUNC** then **SPLIT** **CALL** • Turns the split function ON and OFF after pushing [FUNC].
 - This function is available in the VFO mode only.

36 IF SHIFT CONTROL [SHIFT] (pgs. 22, 24)

- Shifts the center frequency of the main band IF in SSB and CW modes.
- Can be used as the sub tuning dial according to the L-set mode selection.
 - See the description of **37** for details.

FUNCTION

The **IF shift** electronically changes the IF passband frequency to reject interference. The IF shift is especially effective in SSB operation and is not available in FM operation.

37 RIT CONTROL [RIT] (pgs. 22, 24)

- Shifts the main band receive frequency without changing the transmit frequency while the RIT function is ON.
 - Rotate the control clockwise to increase the receive frequency, or rotate the control counterclockwise to decrease the receive frequency.
 - The shift frequency resolution can be selected for SSB/CW and FM separately using the L-set mode.
 - SSB/CW: 1 Hz (100 Hz), 10 Hz (1 kHz), 20 Hz (2 kHz)
 - FM : 10 Hz (1 kHz), 50 Hz (5 kHz), 100 Hz (10 kHz)
 - Bracketed values are maximum shift frequencies in each direction.
- Can be used as the sub tuning dial according to the L-set mode selection.

FUNCTION

The **sub tuning dial** allows you to change the frequency without using the tuning dial. Tuning speed varies according to the control rotation. However, this is not a scan function, therefore, tuning does not stop, even when detecting a signal. This control is convenient when you want to search both the main and sub bands.

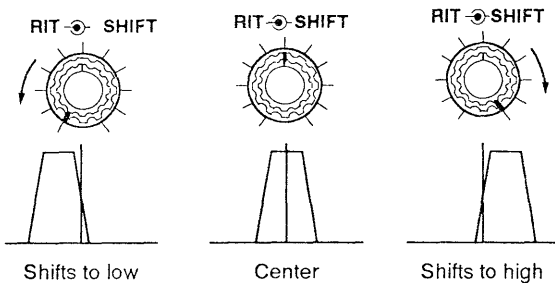

■ Rear panel

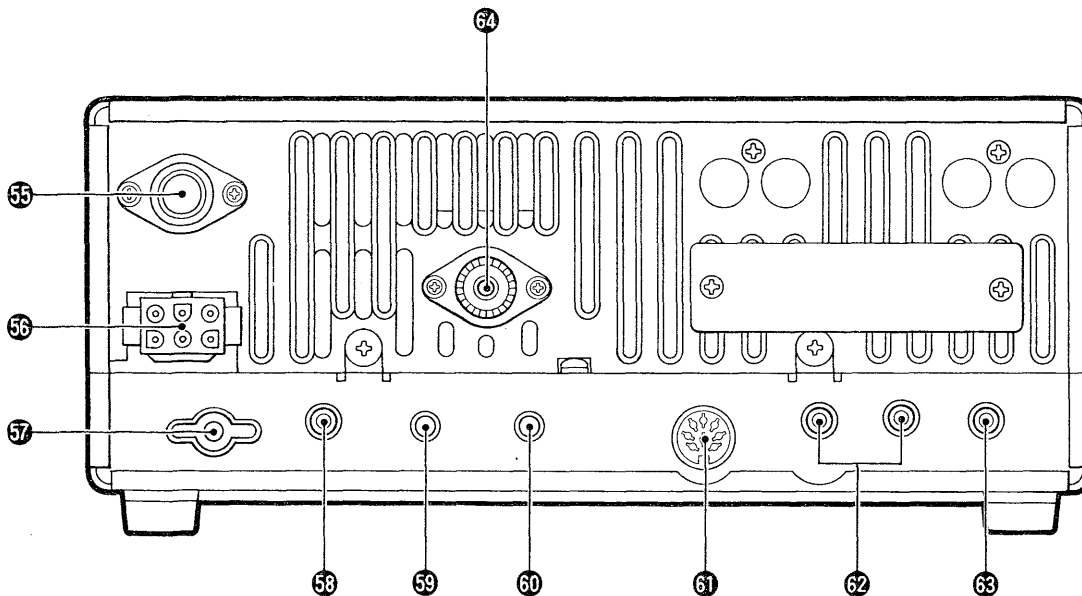

55 430 MHz BAND ANTENNA CONNECTOR [430MHz ANT] (p. 10)
Connects a 430 MHz band antenna with a type-N connector.

56 DC POWER SOCKET [DC 13.8V] (p. 12)
Accepts 13.8 V DC through the supplied DC power cable (OPC-025A).

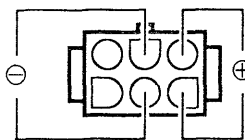

Rear panel view

57 GROUND TERMINAL [GND] (p. 11)
Connect this terminal to a ground to prevent electrical shocks, TVI, BCI and other problems.

58 CW KEY JACK [KEY] (p. 11)
Accepts a CW keyer or external electronic keyer for CW operation.
- 3.5 mm diam. mini plug can be connected.

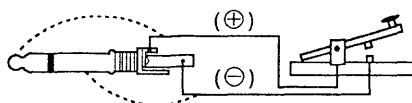

59 BREAK-IN DELAY TIME CONTROL [DELAY] (p. 18)
Adjusts the transmit-to-receive switching delay time for CW semi break-in operation.

60 CW SIDE TONE CONTROL [CW SIDE TONE] (p. 18)
Adjusts the CW side tone level to monitor CW keying.

61 ACCESSORY SOCKET [ACC(1)] (p. 9)
Enables connection to external equipment such as a linear amplifier, TNC, etc.

62 EXTERNAL SPEAKER JACKS [MAIN SP]/[SUB SP] (pgs. 13, 52)
Accept a 4 to 8 Ω speaker. An external speaker may be convenient for simultaneous receiving on the main and sub bands.

Audio output	Speaker connection			
	No connection	[MAIN SP] only	[SUB SP] only	Both jacks
Main band	Internal (Mixed)	External (Mixed)	Internal (Separated)	External (Separated)
Sub band	Internal (Mixed)	External (Mixed)	External (Separated)	External (Separated)

63 CI-V REMOTE CONTROL JACK [REMOTE] (pgs. 15, 52)

- Designed for use with a personal computer for remote control of transceiver functions.
- Used for transceive operation with another Icom CI-V transceiver or receiver.

64 144 MHz BAND ANTENNA CONNECTOR [144MHz ANT] (p. 10)
Connects a 144 MHz band antenna with a PL-259 connector.

Accessory socket information

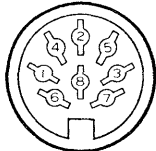
ACC(1)	PIN NO.	PIN NAME	DESCRIPTION	SPECIFICATIONS
 <p>Rear panel view</p>	1	ATVM	ATV microphone input.	—
	2	ATVME	Ground for microphone input.	—
	3	SEND	Input/output pin. Goes to ground when transmitting. When grounded, transmits.	Ground level : -0.5 to 0.8 V Input current : Less than 200 mA
	4*	MOD	Modulator input. The input level is selectable.	Input impedance : 10 kΩ or 300 Ω Input level : 100 or 2 mV rms
		PACT	Direct modulator input for 9600 bps packet operation.	Regular input level : 1.0 Vp-p (0.35 V rms) Max. input level : 1.6 Vp-p (0.56 V rms)
	5*	AF	Main or sub band AF detector output (squelched).	Output impedance : 4.7 kΩ Output level : 100 to 300 mV rms
			Direct detector output during 9600 bps packet operation.	Fixed, regardless of [AF] position.
	6*	SQLS	Main or sub band squelch output. Goes to ground when squelch opens.	Squelch open : Less than 0.3 V/5 mA Squelch closed : More than 6.0 V/100 μA
7	13.8 V	13.8 V output when power is ON.	Output current : Max. 1 A	
8*	ALC	ALC voltage input/output.	Control voltage : -4 to 0 V Input impedance : More than 10 kΩ	
	MIC UD	Microphone up/down input.	Same as the [MIC] connector pin ③ below.	

* The functions of pins 4, 5, 6 and 8 are selectable via the internal switches. (pgs. 47, 48)

Microphone (HM-12; optional)

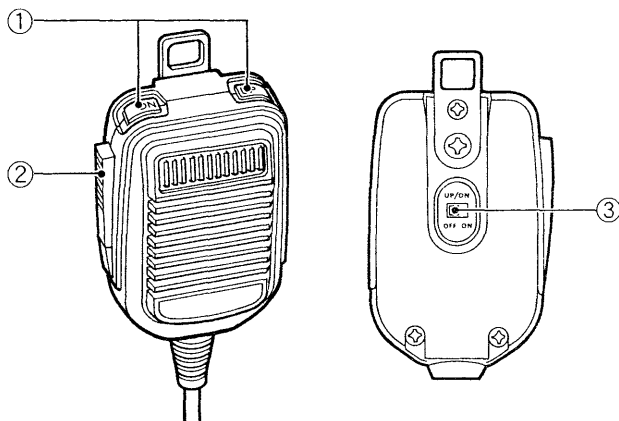

(Front panel view)

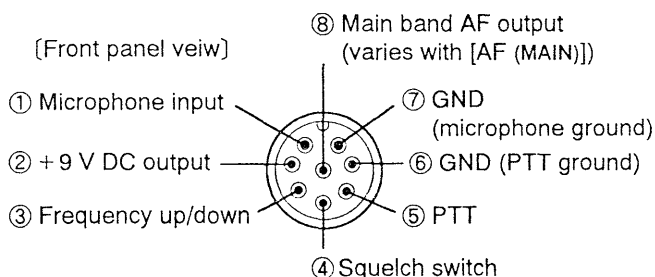

PIN NO.	FUNCTION	DESCRIPTION
②	+9 V DC output	Max. 10 mA
③	Frequency up	Ground
	Frequency down	Ground through 470 Ω
④	Squelch open	"LOW" level
	Squelch closed	"HIGH" level

① UP/DOWN SWITCHES [UP]/[DN]

Change the operating frequency or memory channel.

- Continuous pushing changes the frequency or memory channel number continuously.

② PTT SWITCH (p. 25)

Push and hold to transmit; release to receive.

③ UP/DOWN ON/OFF SWITCH [ON/OFF]

Activates and deactivates the [UP]/[DN] switch control to prevent accidental frequency changes.

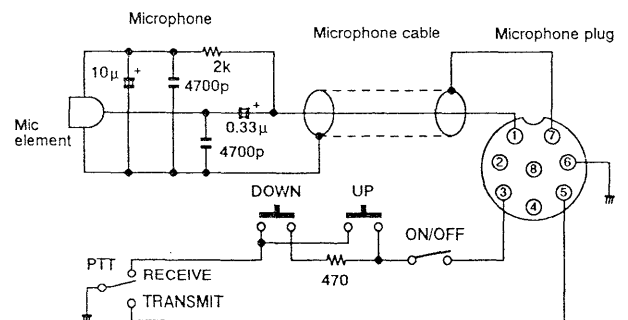

CAUTION: DO NOT short pin 2 to ground as this can damage the internal 9 V regulator.

■ Unpacking

After unpacking, immediately report any damage or missing items to the delivering carrier or dealer. Keep the shipping cartons.

For a description and a diagram of accessory equipment included with the transceiver, see UNPACKING on the inside front page (p. i) of this manual.

■ Antenna

For radio communications, the antenna is of critical importance, along with output power and sensitivity. Select good antennas and mounting locations. The transceiver accepts a 50 Ω antenna and less than 3:1 of Voltage Standing Wave Ratio (VSWR).

The transceiver requires 2 antennas for 144 and 430 MHz operation. Of course, the transmission line should be a coaxial cable.

■ Selecting a location

Select a location for the transceiver that allows adequate air circulation, free from extreme heat, cold, or vibrations, and away from TV sets, TV antenna elements, radios and other electro-magnetic sources.

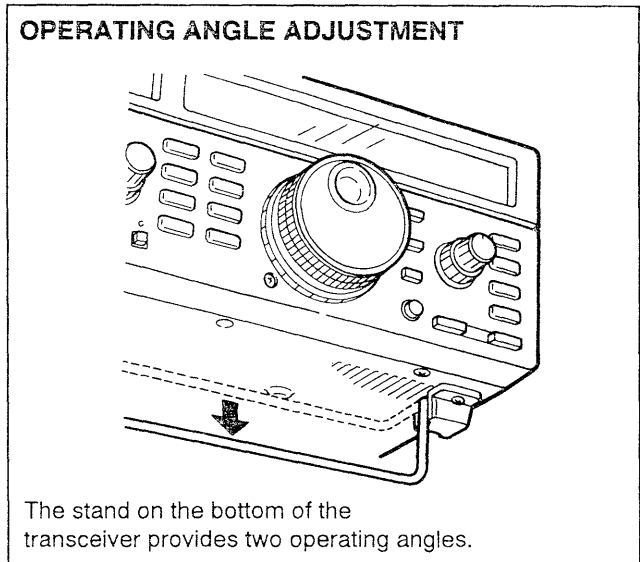

■ Antenna connectors

PL-259 CONNECTOR INSTALLATION (for 144 MHz antenna)

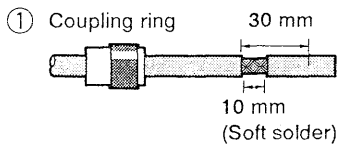

Slide the coupling ring down, Strip the cable jacket and soft solder.

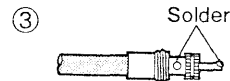

Slide the connector body on and solder it.

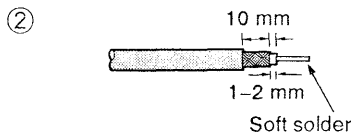

Strip the cable as shown at left. Soft solder the center conductor.

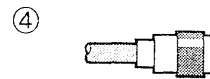

Screw the coupling ring onto the connector body.

30 mm ≈ 9/8 in 10 mm ≈ 3/8 in 1-2 mm ≈ 1/16 in

TYPE-N CONNECTOR INSTALLATION (for 430 MHz antenna)

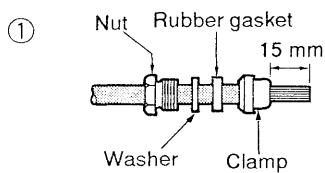

Slide the parts, as shown at left, down. Cut the end of the cable evenly.

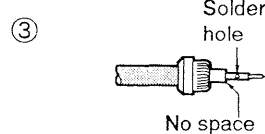

Soft solder the center conductor. Install the pin and solder it.

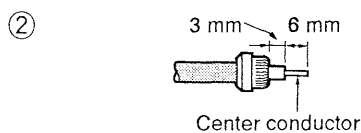

Strip the cable and fold the braid back over the clamp. Evenly trim the braid ends.

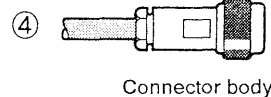

Slide the connector body on and tighten the nut.

15 mm ≈ 5/8 in 6 mm ≈ 1/4 in 3 mm ≈ 1/8 in

Required connections

• Front panel

MICROPHONE

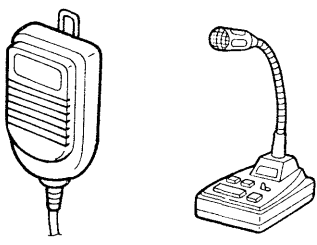

For phone operation (FM or SSB), connect a microphone to this connector. See p. 52 for optional microphone details.

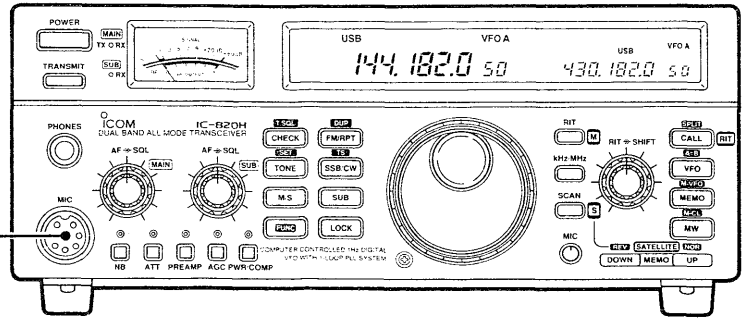

• Rear panel

POWER SUPPLY

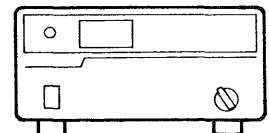

See the next page for details.

430 MHz ANTENNA

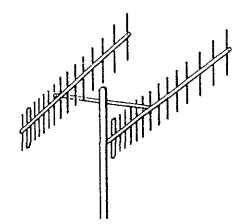

144 MHz ANTENNA

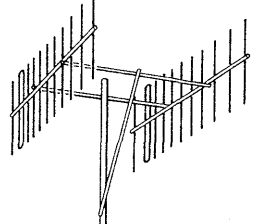
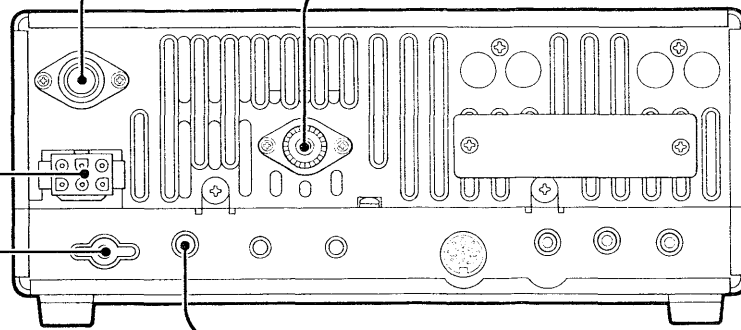
GROUNDING

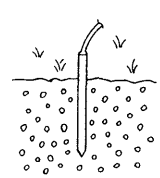

Use the heaviest gauge wire or strap available and make the connection as short as possible.

Grounding prevents electrical shocks, TVI and other problems.

KEY JACK

For CW operation, the transceiver accepts a straight key or an external electronic keyer.

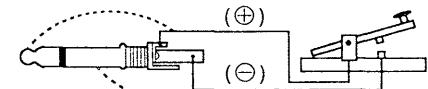

Power supply connections

Use an optional PS-55, IC-PS15 or IC-PS30 DC POWER SUPPLY when operating the transceiver with AC power. Refer to the diagram below.

NOTE: The PS-55 and IC-PS15 DC POWER SUPPLIES cannot be used with Europe and Sweden versions. Use a non-Icom DC power supply as described in the diagram below.

CAUTION: Before connecting the DC power cable, check the following important items. Make sure:

- The [POWER] switch is OFF.
- Output voltage of the power source is 12–15 V when you use a non-Icom power supply.
- DC power cable polarity is correct.
Red : positive ⊕ terminal
Black : negative ⊖ terminal

CONNECTING AN ICOM DC POWER SUPPLY

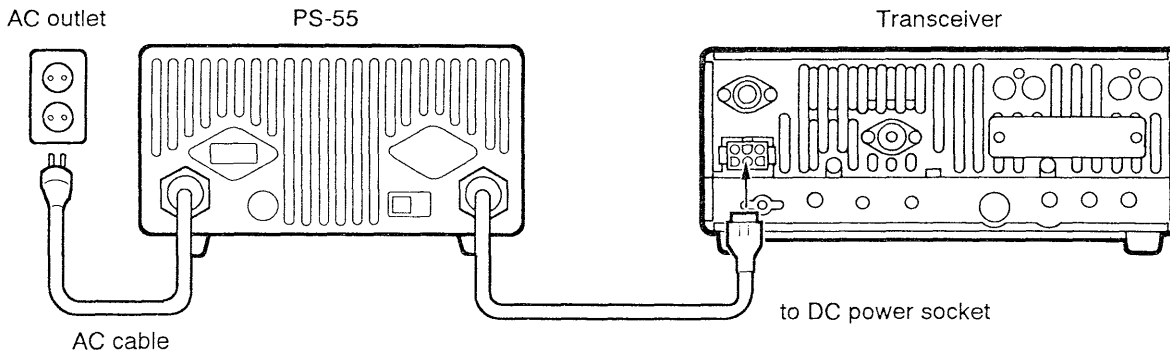

CONNECTING A NON-ICOM DC POWER SUPPLY

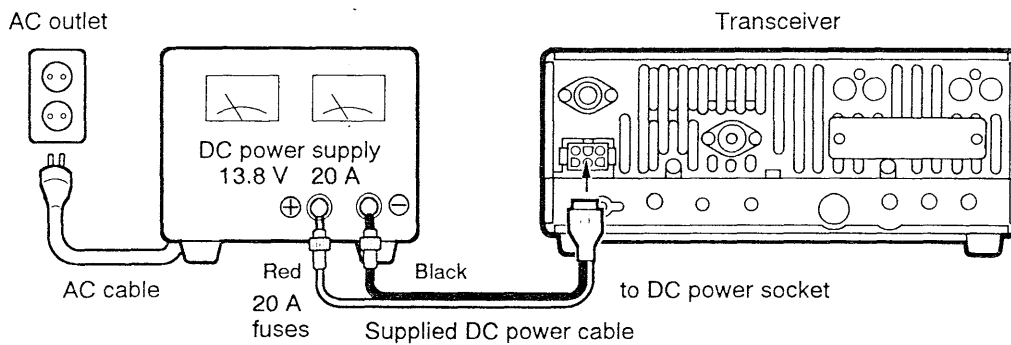

CONNECTING A VEHICLE BATTERY

NOTE: Use terminals for the cable connections.

NEVER connect
to a 24 V battery.

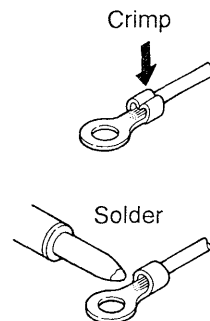
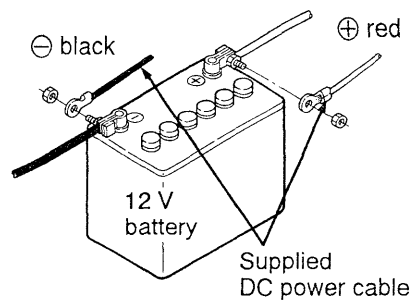
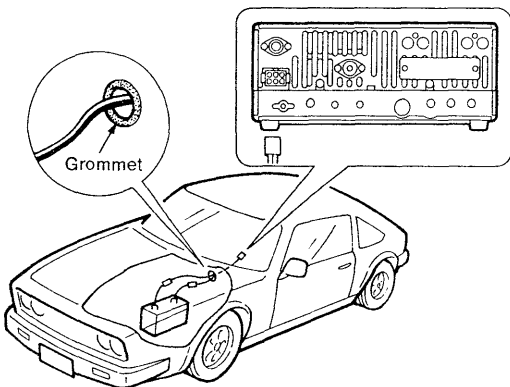

3

ADVANCED CONNECTIONS

Optional connections

• Front panel

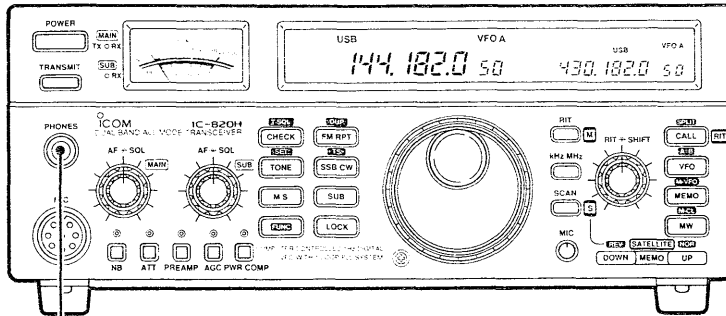

HEADPHONES

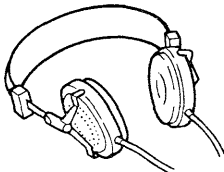

When using stereo headphones, the main and sub band audio can be separated. See p. 47 for mixed audio.

MB-23 CARRYING HANDLE

For portable operation.

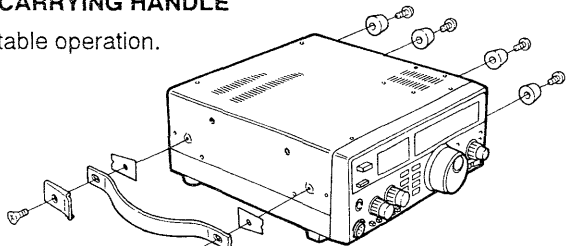

DO NOT use the screws supplied with the MB-23.

• Rear panel

ANTENNA MOUNTING TYPE PREAMPLIFIER

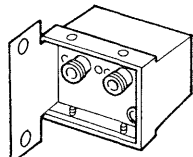

144 MHz band AG-25
430 MHz band AG-35

COMPUTER CONTROL AND TRANSCEIVE (p. 15)

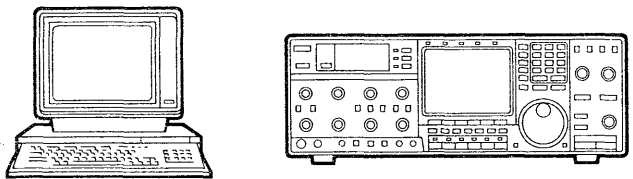
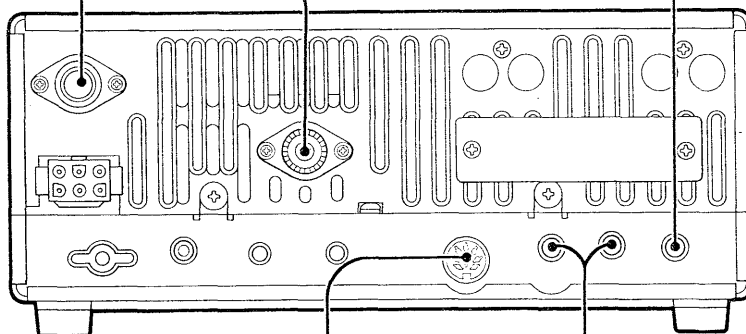

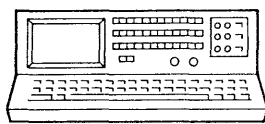

DATA COMMUNICATIONS TERMINAL UNIT (pgs. 14, 18)

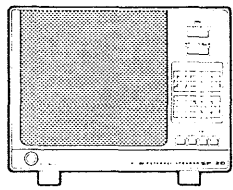

EXTERNAL SPEAKERS

Up to 2 external speakers can be connected for separate audio output of the main and sub bands. (p. 52)



Linear amplifier connections

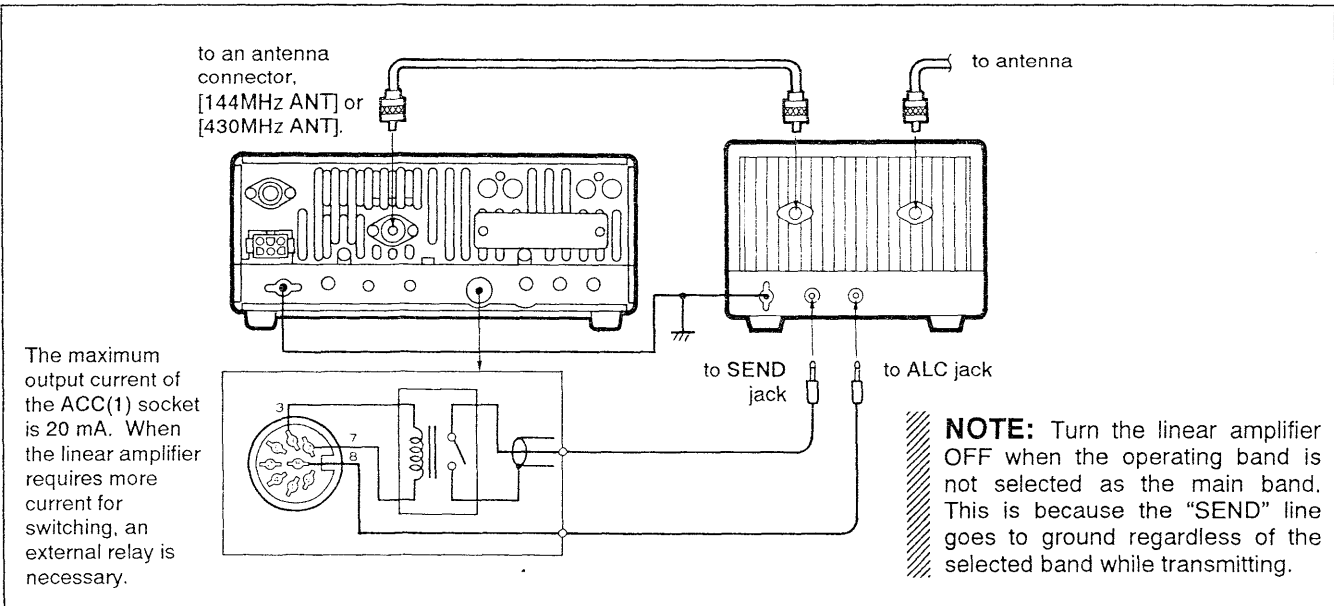

AFSK terminal unit connections

The transceiver does not have an FSK mode for RTTY, AMTOR, PACKET, etc., however, you can operate these using AFSK in SSB or FM mode.

The transceiver accepts data speed of up to 9600 bps. When using 9600 bps, set the internal switch to the "PACT" (packet) position. Refer to p. 48 for switch location.

When operating AFSK, connect external equipment to the ACC(1) socket on the rear panel or to the microphone connector on the front panel as in the diagram below.

When connected to the [MIC] connector, [MIC] and [AF] control adjustments are required. The [MIC] connector accepts up to 1200 bps.

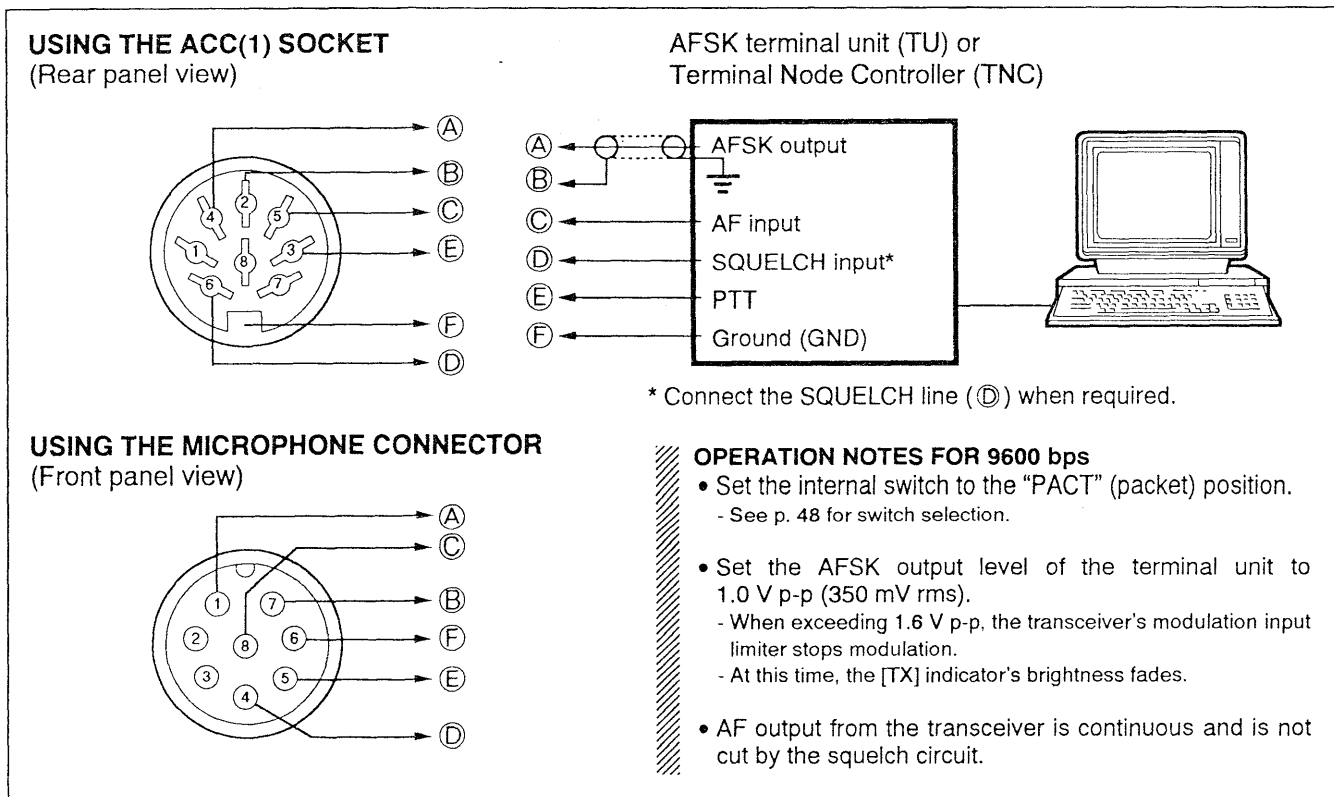

Remote jack (CI-V) information

CI-V connection example

The transceiver can be connected through an optional CT-17 CI-V LEVEL CONVERTER to a personal computer equipped with an RS-232C port. The Icom Communication Interface-V (CI-V) controls the following functions of the transceiver.

Up to four Icom CI-V transceivers or receivers can be connected to a personal computer equipped with an RS-232C port. See p. 43 for setting the CI-V condition using the L-set mode.

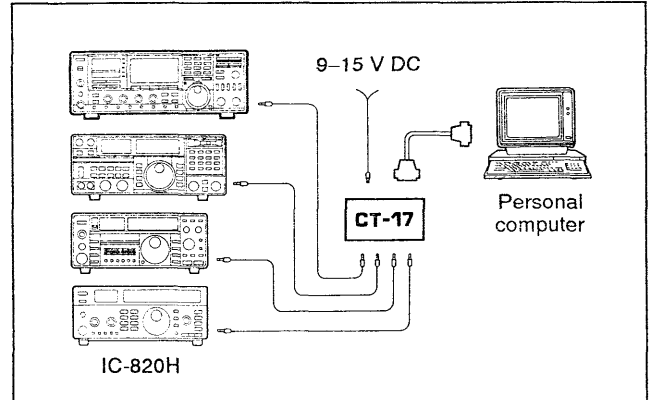

Data format

The CI-V system can be operated using the following data formats. Data formats differ according to command numbers. A data area is added for some commands.

CONTROLLER TO IC-820H

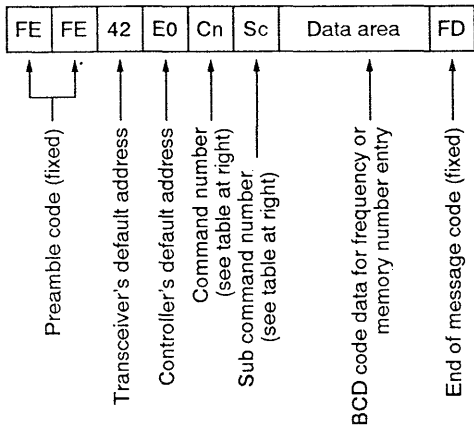

OK MESSAGE TO CONTROLLER

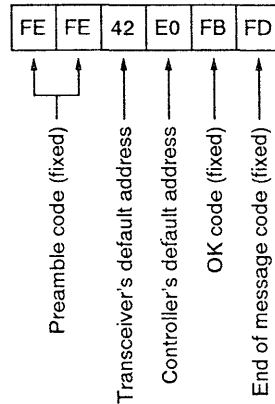

IC-820H TO CONTROLLER

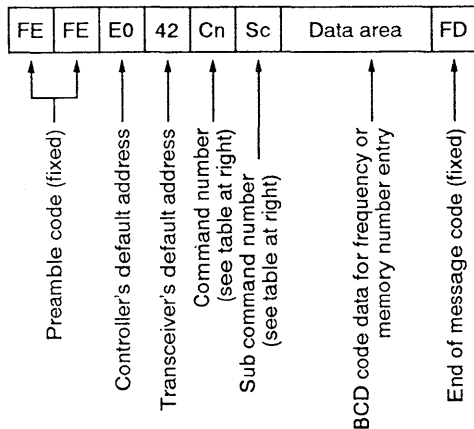

NG MESSAGE TO CONTROLLER

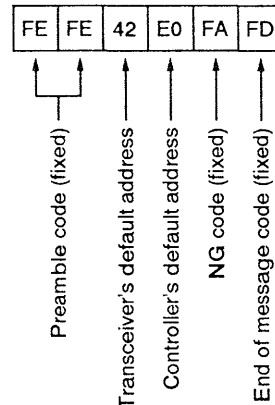

COMMAND TABLE

Description	Cn	Sc	
Frequency control	05	-	
Operating mode control	06	LSB	00
		USB	01
		CW normal	0301
		CW narrow	0302
		FM	05
VFO mode	-	-	
VFO A	-	00	
VFO B	-	01	
A=B	07	A0	
MAIN/SUB	-	B0	
Sub band access	-	D0	
Main band access	-	D1	
Memory mode	08	-	
Memory selection	-	mc*	
Memory write	09	-	
Memory ► VFO	0A	-	
Memory clear	0B	-	
Offset read	0C	-	
Offset write	0D	-	
Scan stop	-	00	
Start scan	0E	01	
Start mode select scan	-	24	
Split ON	-	00	
Split OFF	-	01	
Simplex selection	0F	10	
Duplex - selection	-	11	
Duplex + selection	-	12	

* Memory channel number
P1=100, P2=101, CALL=102

■ When first applying power

Before first applying power, make sure all connections required for your system are complete by referring to sections 2 and 3. Then, reset the transceiver using the following procedure.

NOTE: Resetting **CLEARs** all programmed contents in memory channels and returns programmed values in the set, F- and L- modes to default values.

- ① Make sure the transceiver power is OFF.
- ② While pushing [MW•M-CL], push IN [POWER] to turn power ON.
 - The internal CPU is reset.
 - The transceiver displays its initial VFO frequencies when resetting is complete.

[CPU RESETTING]

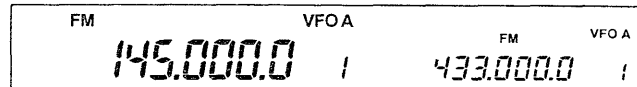
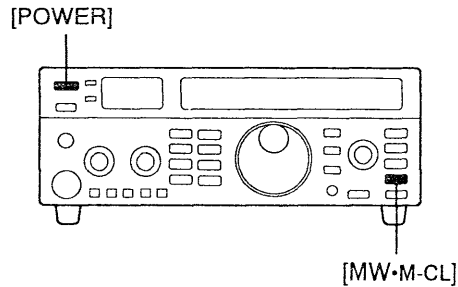

The transceiver displays its initial frequencies.
(The initial frequency and mode depend on versions.)

■ Initial settings

After resetting the transceiver, set controls and switches as shown in the figure below.

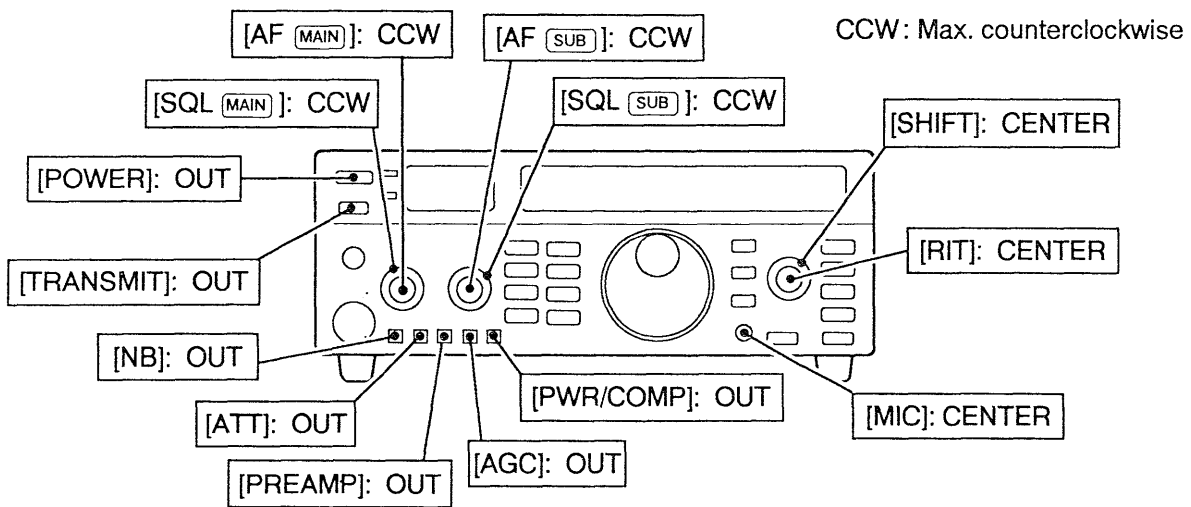

Turn power ON, then check the display.
If any of the following indicators appear, turn them OFF as followings:

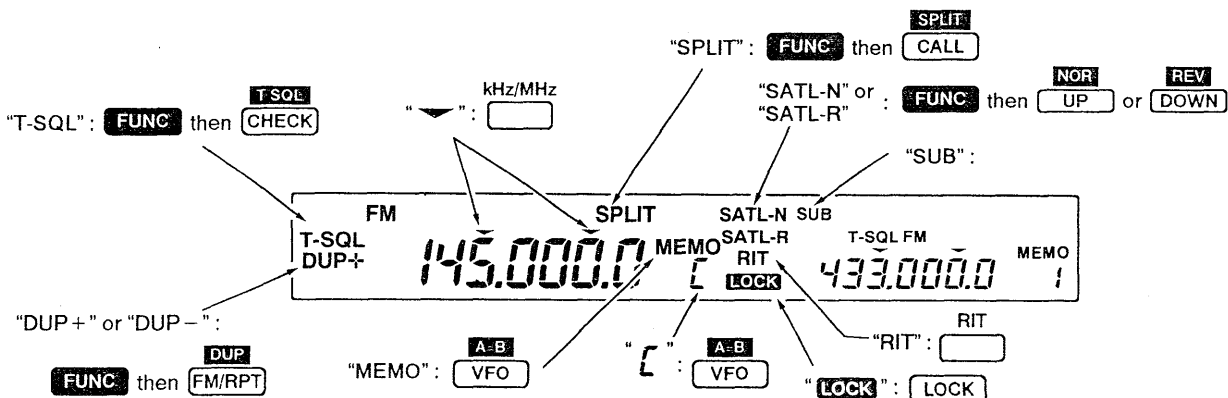

Basic FM operation

- ① Make sure the initial settings are complete.
- ② Push [M/S] to select the desired band, VHF or UHF, as the main band.

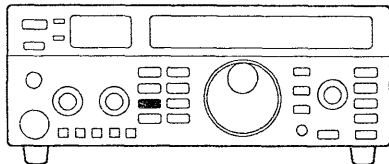

- ③ Push [FM/RPT] to select FM mode.
 - When pushing [FM/RPT] twice, duplex and tone is turned ON simultaneously for the U.S.A. and Australia versions. See p. 27 for setting the duplex direction.

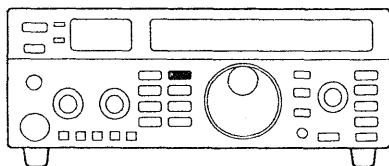

- ④ Rotate [AF (MAIN)] clockwise to adjust the desired audio output level.
- ⑤ Rotate [SQL (MAIN)] clockwise until the audio noise just disappears.

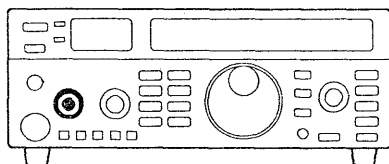

- ⑥ Rotate the tuning dial to set the desired frequency.
 - See p. 21 for frequency setting details.
 - When receiving a signal, the S/RF meter shows the relative signal strength.

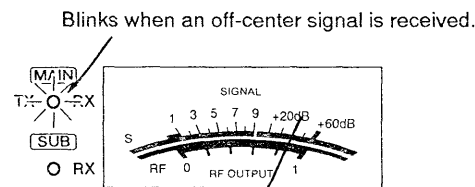

- ⑦ Push the PTT switch on the microphone to transmit. Then, release the PTT switch to return to receive.

- Convenient functions for FM mode**
- Attenuator (pgs. 23, 39)
 - Pre-amplifier (optional) (pgs. 23, 40)
 - FM center indicator (pgs. 24, 40)
 - Repeater operation (p. 27)
 - Split frequency operation (p. 26)
 - Tone squelch function (optional) ... (pgs. 26, 45)

Basic SSB operation

- ① Make sure the initial settings are complete.
- ② Push [M/S] to select the desired band, VHF or UHF, as the main band.

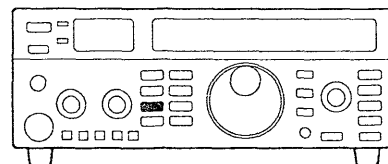

- ③ Push [SSB/CW] to select USB mode.
 - USB mode is generally used for SSB phone operation on the VHF and UHF bands.
 - Pushing [SSB/CW] sequentially selects USB, LSB, CW and the optional CW-Narrow mode.

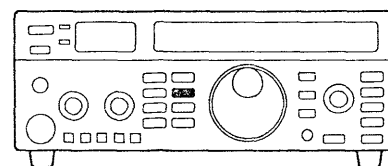

- ④ Rotate [AF (MAIN)] clockwise to adjust the desired audio output level.
 - Adjust the [SQL (MAIN)] control when you want to eliminate the floor noise.
- ⑤ Rotate the tuning dial to set the desired frequency.
 - See p. 21 for frequency setting details.
 - When receiving a signal, the S/RF meter shows the relative signal strength.

- ⑥ Push the PTT switch on the microphone to transmit. Then, release the PTT switch to return to receive.
 - When the [TX] indicator often lights brightly during transmission (ALC activates), rotate the [MIC] control counterclockwise.

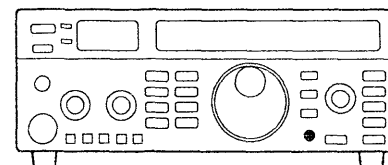

- Convenient functions for SSB mode**
- IF shift function (p. 24)
 - RIT function (p. 24)
 - Noise blanker (p. 23)
 - Attenuator (pgs. 23, 39)
 - Pre-amplifier (optional) (pgs. 23, 40)
 - AGC fast (p. 23)
 - Speech compressor (pgs. 25, 26, 47)
 - ALC indicator (p. 25)
 - Split frequency operation (p. 26)

Basic CW operation

- Connect a CW keyer or an external electronic keyer to the [KEY] jack on the rear panel.
- See p. 11 for connection details.

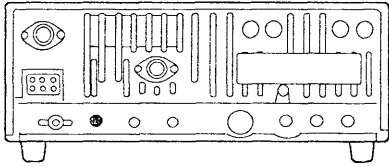

- Make sure the initial settings are complete.
- Push [M/S] to select the desired band, VHF or UHF, as the main band.
- Push [SSB/CW] to select CW or CW-Narrow* mode.
- Pushing [SSB/CW] sequentially selects USB, LSB, CW and the optional CW-Narrow mode.
* An optional FL-132 CW NARROW FILTER is necessary to operate the CW-Narrow mode. The optional CW-Narrow mode can be used on the main band only.

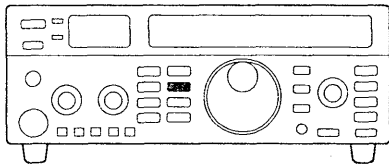

- Rotate [AF (MAIN)] clockwise to adjust the desired audio output level.
- Adjust the [SQL (MAIN)] control when you want to eliminate the floor noise.
- Rotate the tuning dial to set the desired frequency.
- See p. 21 for frequency setting details.
- When receiving a signal, the S/RF meter shows the relative signal strength.
- Push the connected key down to transmit the CW signal.
- When the break-in function is OFF in the F-set mode, push IN the [TRANSMIT] switch in advance. (p. 40)
- Adjust [DELAY] control to your desired switching speed for returning transmit to receive.

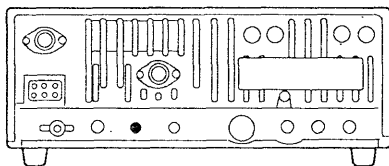

- Adjust [CW SIDE TONE] to the desired CW side tone level.
- The side tone level can be changed relative to both [AF] and [CW SIDE TONE] controls. (p. 47)

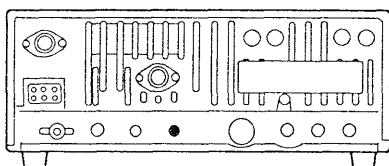

Convenient functions for CW mode

- IF shift function (p. 24)
- RIT function (p. 24)
- Noise blanker (p. 23)
- Attenuator (pgs. 23, 39)
- Pre-amplifier (optional) (pgs. 23, 40)
- AGC slow (p. 23)
- Split frequency operation (p. 26)
- CW-Narrow mode (optional) (p. 45)

Basic AFSK operation

Set the internal switches to an appropriate position in advance. (pgs. 47, 48) Connect an external equipment to the ACC(1) socket as described on pgs. 9 and 14.

- Turn power ON with [POWER].
- Select LSB, USB or FM.
- LSB is normally used.
- FM is used for PACKET.
- Set the desired frequency.
- Adjust the audio output level with [AF].
- Use [SQL] when required.
- Select the desired RF output power.
- When using the [MIC] connector for external equipment connection, the [MIC] control should be adjusted.
- Control the transceiver from the external TU or TNC.

Operating notes for RTTY and AMTOR

- RTTY or AMTOR operating frequency in LSB mode differs from the displayed frequency.
[Your operating freq.] = [Displayed freq.] - 2125 Hz
(when the frequencies of the RTTY demodulator in your TU or TNC are mark=2125 Hz and space=2295 Hz).

Operating notes for PACKET

- PACKET operating frequency in LSB mode differs from the displayed frequency.
[Your operating freq.] = [Displayed freq.] - 2215 Hz
(when the frequencies of the PACKET demodulator in your TNC are 2115 Hz/2315 Hz).

Frequency setting example for AFSK

- When operating RTTY at 144.090 MHz:
Set "LSB 144.092125 MHz" (if you use mark=2125 Hz/space= 2295 Hz).
- When operating PACKET at 144.110 MHz:
Set "LSB 144.112215 MHz" (if you use 2115 Hz/ 2315 Hz).

■ Main and sub bands

The transceiver has dual bands: VHF and UHF. These bands can be assigned to the main and sub bands for operating convenience.

The main and sub bands each have independent features as described below:

The display shows the VHF and UHF bands are assigned to the main and sub bands, respectively.

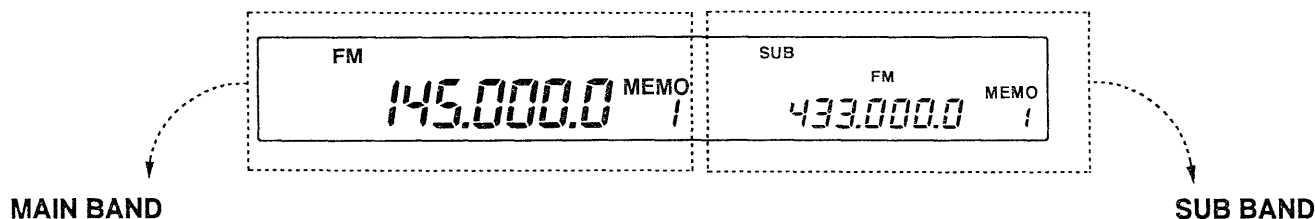

MAIN BAND

- Receive and transmit are both possible.
- Uplink frequency when operating in the satellite mode.
- Scan function can be used.
- IF shift function can be used.
- RIT function can be used.
- CW-Narrow mode can be used when the optional FL-132 CW NARROW FILTER is installed. (p. 45)
- Analog meter for receive S-meter and transmit power meter.
- FM center indicator is used for critical tuning. (p. 40)
- Low beep tone is emitted when a switch is pushed for the main band and the beep tone can be turned OFF if desired. (p. 41)

SUB BAND

- Receive only.
- Downlink frequency when operating in the satellite mode.
- IF shift cannot be used.
- RIT function can be used only when operating in the satellite mode.
- CW-Narrow mode cannot be used even when the optional FL-132 CW NARROW FILTER is installed.
- A bar meter equipped in the function display can be turned OFF if desired. (p. 40)
- High beep tone is emitted when a switch is pushed for the sub band and the beep tone can be turned OFF if desired. (p. 41)
- Duplex, split, offset and [PWR/COMP] switch selection cannot be performed.

■ Exchanging the main and sub bands

The function display shows both the main and sub band frequencies and both bands can receive signals simultaneously. Assign VHF or UHF, whichever band you want to transmit or be called on, as the main band.

- Push [M/S] to exchange the main and sub bands.

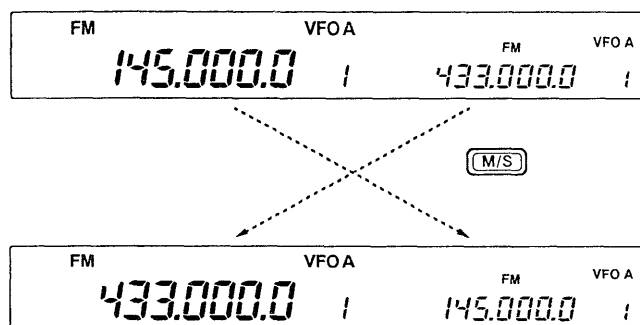

■ Accessing the sub band

Frequency control, memory operation and some functions can be operated on the sub band. You can search the sub band while standing by on the main band for quick response to received calls.

- ① Push [SUB] to access the sub band.
 - "SUB" appears on the function display.
 - You can transmit on the main band even when accessing the sub band.
- ② Push [SUB] again to return to the main band control.

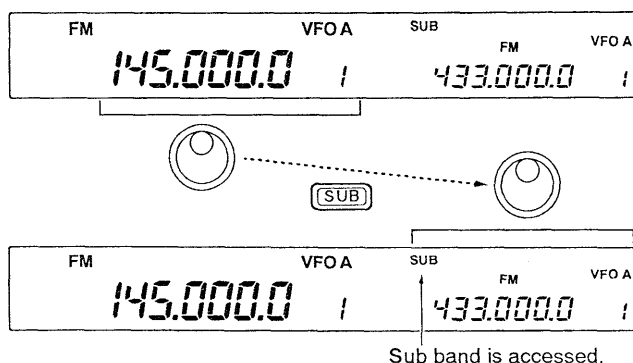

VFO description

The transceiver has two VFOs for both bands, specially suited for instant selection of 2 frequencies or split frequency operation. The VFOs are called VFO A and VFO B. You can use a desired VFO to call up a frequency and operating mode for your operation.

VFO is an abbreviation of Variable Frequency Oscillator, and traditionally refers to an oscillator.

CONVENIENT

Use two VFOs as a quick memory

When you find a new station but you wish to continue searching, the two VFO system can be used for quick memory storage.

- ① Push [FUNC] then [VFO•A=B] for 2 sec. to store the displayed frequency into the undisplayed VFO.
- ② Continue searching stations.
- ③ Push [VFO] to retrieve the stored frequency.
- ④ To continue searching stations, push [VFO] again.

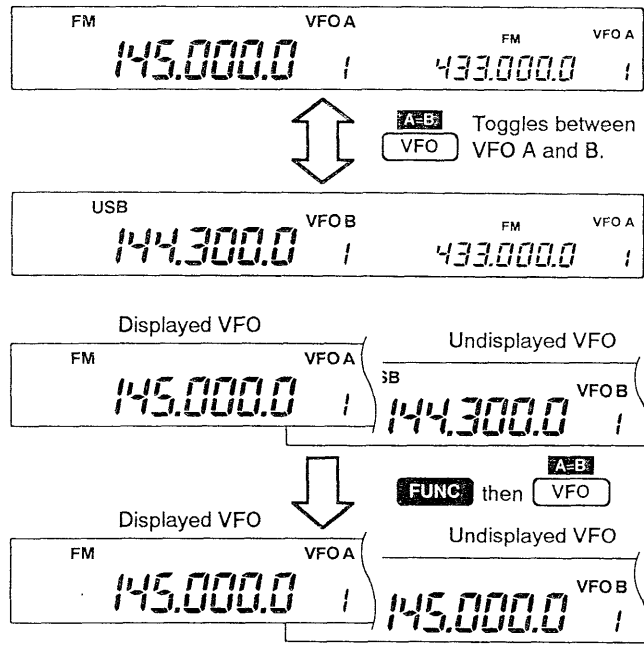

The differences between the VFO mode and the memory mode

VFO MODE

Each VFO shows a frequency and operating mode. If the frequency or operating mode is changed, the VFO automatically memorizes the new frequency or new operating mode.

When a VFO is selected from another VFO or the memory mode, the last used frequency and operating mode for that VFO appear.

[EXAMPLE]

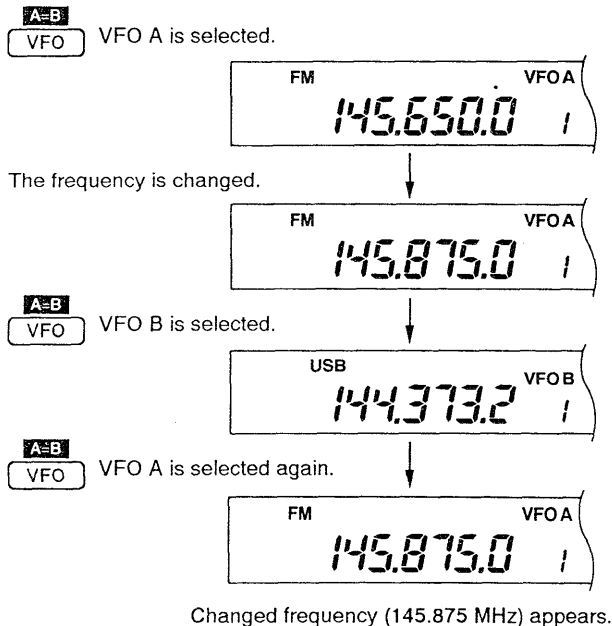

MEMORY MODE (pgs. 29–32)

Each memory channel shows a frequency and operating mode like a VFO. Even if the frequency or mode is changed, the memory channel does not memorize the new frequency or operating mode.

When the memory channel is selected from another memory channel or VFO mode, the memorized frequency and operating mode appear.

[EXAMPLE]

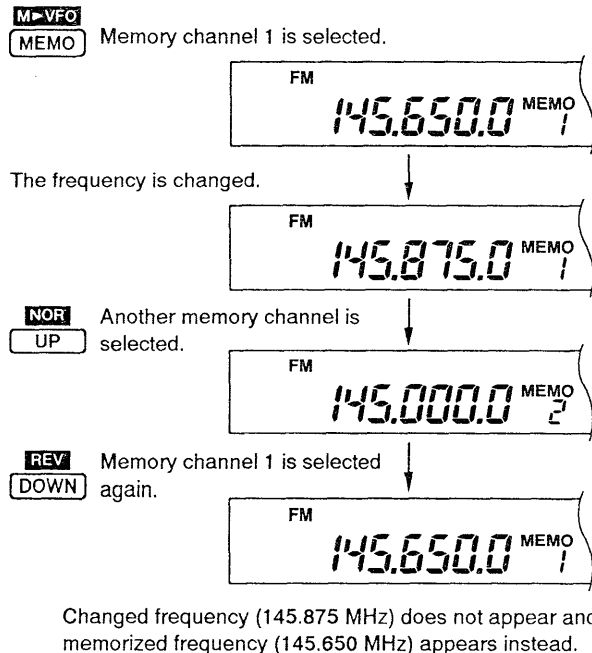

Frequency setting

The transceiver has a [kHz/MHz] switch and user-programmable tuning steps for convenient frequency tuning.

- ① Push [M/S] to select the desired frequency band as the main band; or push [SUB] to access the sub band.
- ② Push [VFO] to select the VFO mode.
- ③ Rotate the tuning dial to set the frequency.
 - When SSB or CW mode is selected, the memory channel number changes to the 10 and 1 Hz digits when rotating the tuning dial except when the 100 Hz tuning step is selected. (This can be turned OFF using the L-set mode. See p. 41.)
 - When you want to check the 10 and 1 Hz digits, push and hold [FUNC].

10 and 1 Hz DIGIT INDICATIONS (SSB/CW only)

When rotating the tuning dial or pushing [FUNC] more than 1 sec.

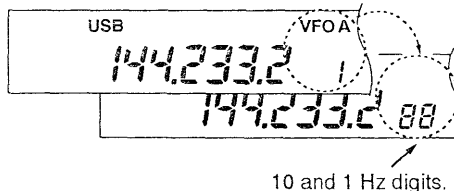

10 and 1 Hz digits.

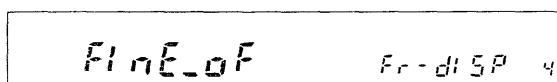

When you do not require the 10 and 1 Hz indications, set "FINE-oF" in the L-set mode item 4. (p. 41)

QUICK TUNING STEPS

The operating frequency can be changed in 1 kHz steps or 1 MHz steps for quick tuning.

- For 1 kHz tuning: Push [kHz/MHz] momentarily.

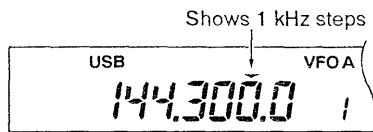

Push [kHz/MHz] again to return to the normal steps.

- For 1 MHz tuning: Push [kHz/MHz] for 2 sec.

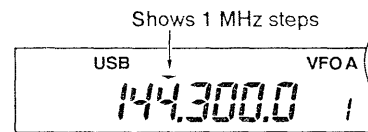

Push [kHz/MHz] again to return to the normal steps.

TUNING STEP SELECTION

Tuning steps can be pre-set independently for FM and SSB/CW. The following steps are selectable.

- FM : 0.1, 5, 10, 12.5, 20, 25 or 100 kHz
- SSB : 1, 10, 50 or 100 Hz

- ① Push [M/S] or [SUB] to select the desired band.
- ② Push [FM/RPT] or [SSB/CW] to select the desired operating mode.
- ③ Push [FUNC], then push [SSB/CW•TS] to indicate the tuning step setting display.
- ④ Rotate the tuning dial to set the desired steps.
- ⑤ Push [SSB/CW] to return to the previous display.

FM tuning step setting display (Unit: kHz)



SSB/CW tuning step setting display (Unit: Hz)

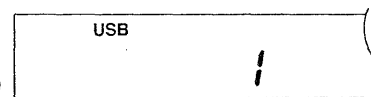

■ Sub tuning dial

The transceiver has a large main tuning dial for frequency setting. In addition, the [RIT] or [SHIFT] controls can be used as a sub tuning dial for dual band simultaneous tuning, etc. The sub tuning dial changes the operating frequency continuously at a variable speed.

To use the sub tuning dial function, assign the function to either the [RIT] or [SHIFT] control using the L-set mode item 7 as described at right.

▨ The assigned control can be used for its original function, however, both functions cannot be used simultaneously.

- ① Assign the function to the [RIT] or [SHIFT] control and the effect to the accessed band or sub band.
 - See the box at right.
- ② Push [FUNC], then push the [RIT] switch.
 - The kHz decimal point of the selected band blinks.
 - "RIT" blinks when the function is assigned to the [RIT] control.

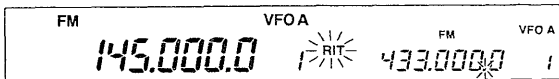

The display shows the function is assigned to the [RIT] control and is activated on the sub band.

- ③ When the sub tuning dial is assigned to the accessed band, push [SUB] to select the desired band for control.
- ④ Set the [RIT] or [SHIFT] control for the desired tuning direction and speed.
 - Tuning speed can be adjusted in ± 5 steps.

Sub dial does not function.

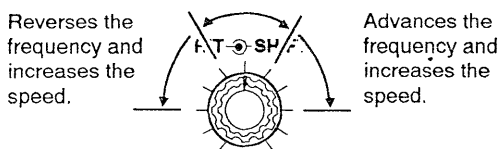

- ⑤ Push [FUNC], then push the [RIT] switch to cancel the function.
 - Pushing [RIT] also cancels the function when the sub tuning dial is assigned to the [RIT] control.

▨ While pushing the [MEMO] switch, the sub tuning dial changes the memory channel.

SUB TUNING DIAL FUNCTION ASSIGNMENT

- ① Turn power OFF.
- ② While pushing [LOCK], turn power ON.
- ③ Push [UP] or [DOWN] to select item 7 (displayed instead of the sub band's memory channel number).
- ④ Rotate the tuning dial to select your desired condition as described below.
- ⑤ Turn the power OFF and ON again to exit the L-set mode.



Sub tuning dial cannot be used.



The [RIT] control can be used for sub band tuning.



The [RIT] control can be used for the accessed band's tuning.



The [SHIFT] control can be used for sub band tuning.



The [SHIFT] control can be used for the accessed band's tuning.

■ Dial lock function

The dial lock function prevents accidental changes caused by the tuning dial (including the sub tuning dial).

- Push [LOCK] to activate and cancel the dial lock function.

Even while the dial lock function is activated, memory channel selection can be made with the tuning dial while pushing the [MEMO] switch.

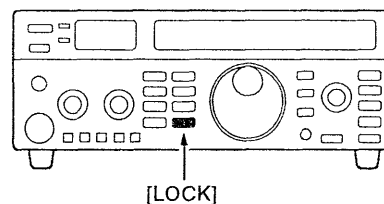

▨ If the optional UT-36 is installed, the transceiver may announce the accessed band's frequency, mode, etc. when the lock function is activated. (pgs. 42, 46)

5

FUNCTIONS FOR RECEIVING

SQUELCH (6, 12 on pgs. 1, 2)
Rotate to close the squelch when you want to cut the no-signal noise in FM mode or to eliminate the floor noise in SSB/CW mode.

S/R/F METER (14 on p. 2)
Shows the main band's receive signal strength.

SUB BAND S-METER (50 on p. 7)
Shows the signal strength of the sub band.

TX/RX INDICATOR (15 on p. 2)
Lights up in green when a signal is received.

Blinks when an off-center signal is received in FM mode.

CHECK (17 on p. 3)
Monitors the frequency without disturbing the accessed band's squelch.

The sub band S-meter can be turned OFF using the F-set mode if desired. See p. 40 for setting the sub band S-meter ON and OFF.

PHONES (6 on p. 1)
Insert headphones when required.

LOCK (21 on p. 3)
Push to activate the dial lock function and to announce the accessed band's frequency when an optional UT-36 is installed.

RIT (23, 37 on pgs. 4, 6)
SHIFT (33 on p. 6)
See the right page for details.

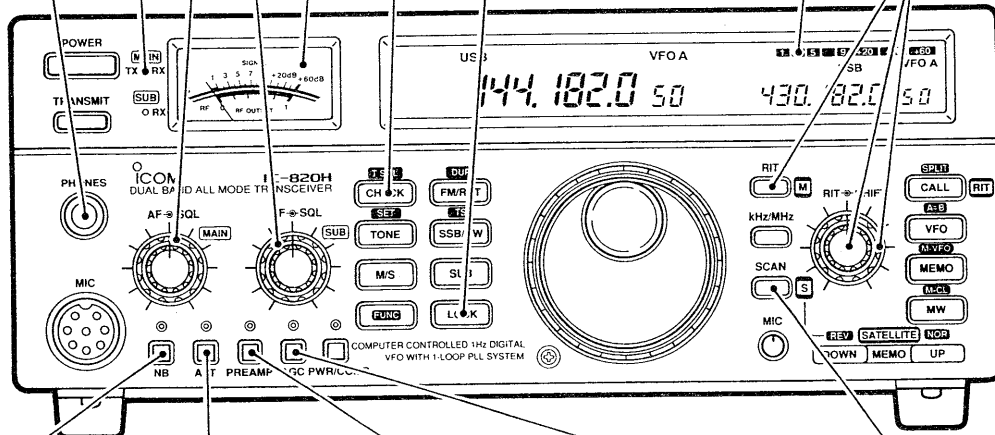

ATT (8 on p. 2)
When receiving interference from strong signals or other sources, the attenuator is helpful to reduce the interference.

The attenuator is turned ON for both bands simultaneously, however, this can be changed to VHF or UHF only using the F-set mode. Refer to p. 39 for setting details.

PREAMP (9 on p. 2)
When connecting an optional preamplifier to an antenna connector, this switch turns the preamp ON and OFF.

See p. 40 for activating band selection.

SCAN (30 on p. 4)
Push to start the scan or optional tone scan.

NB (7 on p. 2)
When operating SSB or CW mode on the main band, pulse-type noise may be received, such as from car ignitions. In this case, the noise blanker eliminates such noise.

NOTE: When using the noise blanker, received signals may be distorted if they are excessively strong.

The noise blanker is not available for FM mode.

AGC (10 on p. 2)
AGC (Auto Gain Control) holds audio output constant during fluctuations in main band signal strength.

- Set AGC slow (OUT) for SSB mode.
- Set AGC fast (IN) for CW mode or when searching for signals with the tuning dial.

The sub band's AGC is automatically selected as slow in SSB and fast in CW. The AGC is not available for FM mode.

RIT function

The RIT (Receive Incremental tuning) function compensates for off-frequencies of communicating stations. The function shifts the receive frequency only up to ± 2.0 kHz in 20 Hz steps in SSB/CW mode (± 10.0 kHz in 100 Hz steps in FM mode) without moving the transmit frequency.

The shift frequency resolution can be selected for SSB/CW and FM modes separately using the L-set mode. (p. 42)

SSB/CW : 1 Hz (100 Hz), 10 Hz (1 kHz), 20 Hz (2 kHz)

FM : 10 Hz (1 kHz), 50 Hz (5 kHz), 100 Hz (10 kHz)

Bracketed values are maximum shift frequencies in each direction.

The RIT function can be used for the main band only and can be adjusted even when accessing the sub band.

- Push the [RIT] switch to activate the function.
 - "RIT" appears.



"RIT" appears.

- Rotate the [RIT] control to cancel the off-frequencies.
 - The transmit frequency is not shifted.
- To cancel the RIT function, push [RIT] again.
 - "RIT" disappears.

▨ The RIT function can not be used with the sub tuning dial function when the sub dial is assigned to the [RIT] control. (pgs. 22, 42)

IF shift function

The IF shift function electronically changes the pass-band frequency of the IF (Intermediate frequency) and cuts out higher or lower frequency components of the IF to reject interference. The function shifts the IF frequency up to ± 1.2 kHz in 100 Hz steps in SSB/CW mode. The IF shift is especially effective in SSB operation and not available in FM mode.

The IF shift function can be used for the main band only.

- Adjust the [SHIFT] control for a minimum interference signal level.
 - The audio tone may be changed while the IF shift is in use.
- Set the [SHIFT] control to its center position when there is no interference.

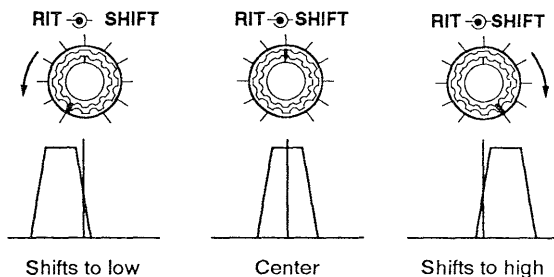

▨ The IF shift function cannot be used with the sub tuning dial function when the sub dial is assigned to the [SHIFT] control. (pgs. 22, 42)

Especially in CW mode, a mechanical noise may sound when rotating the [SHIFT] control, however, it is not a transceiver malfunction.

FM center indicator

The main band RX indicator indicates the received signal deviation in FM mode. When an off-center signal is received, the main band RX indicator blinks.

When an off-center signal is received, rotate the tuning dial or use the RIT function to light up the RX indicator continuously.

The FM center meter can be turned OFF using the F-set mode if desired. See p. 40 for setting the FM center meter ON and OFF.

Blinks when an off-center signal is received.

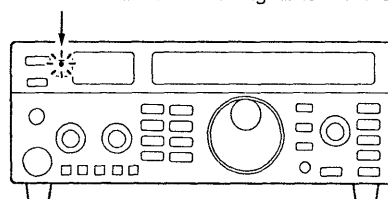

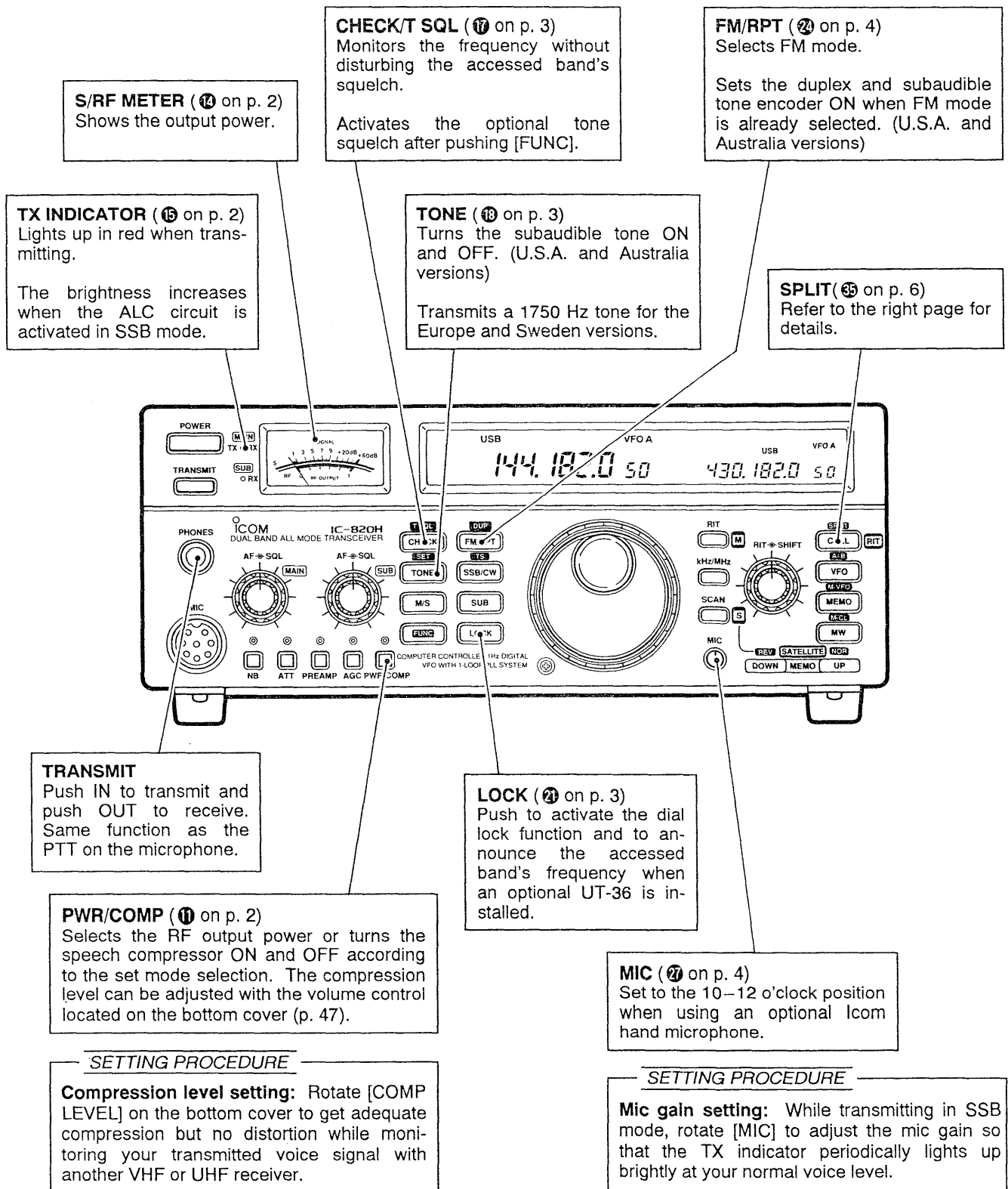

■ Compressor/RF power switch setting

The [PWR/COMP] switch selects the RF output power or turns the speech compressor ON and OFF according to the set mode selection. Set the desired function to [PWR/COMP] as follows:

- ① Cancel the sub band access function in advance.
- ② Push [FUNC] then [TONE•SET] to enter set mode.

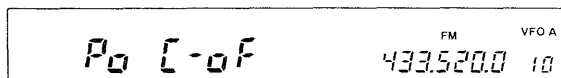

- ③ Rotate the tuning dial to select the desired condition.

DISPLAY	RF POWER	COMPRESSOR
Po C-oF	Selectable	OFF
Po C-on	Selectable	ON
Co P-Lo	Low power	Selectable
Co P-HI	High power	Selectable

- ④ Push [CHECK] to exit the set mode.

■ Split frequency operation

Split frequency operation allows you to transmit and receive on two different frequencies. The split frequency operation is performed using 2 frequencies on 2 VFOs.

- ① Set a receive frequency in the VFO mode.
- Either VFO A or VFO B can be used.
- ② Push [FUNC] then [VFO•A=B] for 2 sec.
- The undisplayed VFO contents are cleared and equalized to the displayed frequency.

- ③ Push [FUNC] then [CALL•SPLIT].
- "SPLIT" appears.
- Now you can receive on the displayed VFO and transmit on the undisplayed VFO.
- ④ To change the receive frequency, rotate the tuning dial. To change the transmit frequency, rotate the tuning dial while pushing [CHECK].
- ⑤ Push [FUNC] then [CALL•SPLIT] to cancel.

To change the transmit and receive frequencies, push [VFO] to exchange VFOs.

■ Tone squelch operation

To operate the tone squelch, an optional UT-50 is required. See p. 45 for installation. Two UT-50s are required for dual band simultaneous operation.

The tone squelch opens only when receiving a signal with the same pre-programmed subaudible tone. You can silently wait for a call from group members using the same tone. You can check the tone frequency using the tone scan if desired. (p. 28)

- ① Select the desired band with the [M/S] switch.
- ② Select FM mode, then set the desired frequency.
- ③ Program the tone squelch frequency as at right.
- ④ Push [FUNC] then [CHECK•T SQL] to turn the tone squelch ON. ("T SQL" appears.)
- ⑤ When the received signal includes the correct tone, the squelch opens and the signal can be heard.
- When the received signal includes an incorrect tone or no tone, the squelch does not open, however, the S-meter indicates the signal strength.
- To open the squelch manually, push and hold [CHECK].

- ⑥ Operate the transceiver in the normal way (push [PTT] to transmit; release [PTT] to receive).
- ⑦ To cancel the tone squelch, push [FUNC] then [CHECK•T SQL].

• Setting the tone squelch frequency

Frequencies can be independently set for each band.

- ① Push [FUNC] then [TONE•SET] to enter set mode.
- ② Push [TONE] 4 times to select the tone squelch frequency setting display.
- When the sub band access is in use, skip this step.
- ③ Rotate the tuning dial to select the desired frequency.
- ④ Push [CHECK] to exit the set mode.

• Tone squelch frequency list

(Unit: Hz)

67.0	82.5	100.0	118.8	141.3	167.9	203.5	241.8
71.9	85.4	103.5	123.0	146.2	173.8	210.7	250.3
74.4	88.5	107.2	127.3	151.4	179.9	218.1	
77.0	91.5	110.9	131.8	156.7	186.2	225.7	
79.7	94.8	114.8	136.5	162.2	192.8	233.6	

■ Operation

A repeater amplifies received signals and transmits them at a different frequency. When using a repeater, the transmit frequency is shifted from the receive frequency by the offset frequency. (p. 28) It is convenient to program repeater information into a memory channel. (p. 30)

- ① Select the desired band as the main band with the [M/S] switch.
- ② Push [FM/RPT] to select FM mode.
- ③ Set the receive frequency (repeater output frequency). (p. 21)
- ④ Push [FUNC] then [FM/RPT•DUP] to select – duplex or push them again for + duplex.
 - “DUP –” or “DUP +” appears to indicate the transmit frequency for minus shift or plus shift, respectively.
 - The U.S.A. and Australia versions have an auto repeater function. (p. 28)

- For the U.S.A. and Australia versions, push [FM/RPT] to set the pre-programmed duplex direction and to turn the subaudible tone encoder ON. See below.

- ⑤ Push and hold [PTT] to transmit.
 - Push and hold [CHECK] to check whether the other station's transmit signal can be directly received or not.
 - The displayed frequency automatically changes to the transmit frequency (repeater input frequency).
 - When the repeater requires a tone, see the section below.
 - If “DUP –” or “DUP +” blinks, confirm the offset frequency.
- ⑥ Release [PTT] to receive.
- ⑦ To return to simplex, push [FUNC] then [DUP] once or twice to clear the “DUP” indicator.
 - For the U.S.A. and Australia versions, push [FM/RPT] to cancel the “DUP” and “T” settings.

■ Tone information

SUBAUDIBLE TONE

(U.S.A. and Australia versions only)

- ① Push [TONE] to turn the subaudible tone encoder ON.
- ② Set the tone frequency if desired.
 - Push [FUNC] then [TONE•SET].

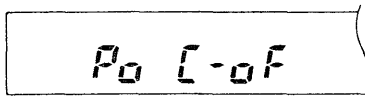

Set mode is selected.

- Push [TONE•SET] 3 times.

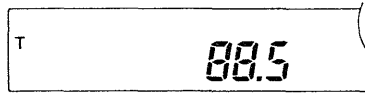

Tone encoder frequency appears.

- Rotate the tuning dial to select the desired tone frequency.

- Push [CHECK] to exit the set mode.

- ③ Push [TONE] to turn the subaudible tone encoder OFF.

• Subaudible tone frequency list

(Unit: Hz)

67.0	82.5	97.4	114.8	136.5	162.2	192.8	233.6
71.9	85.4	100.0	118.8	141.3	167.9	203.5	241.8
74.4	88.5	103.5	123.0	146.2	173.8	210.7	250.3
77.0	91.5	107.2	127.3	151.4	179.9	218.1	
79.7	94.8	110.9	131.8	156.7	186.2	225.7	

DTMF TONES (HM-14 is required.)

Push the desired digit keys on the microphone in sequence to transmit DTMF tones.

1750 Hz TONE (Europe and Sweden versions only)

Push [TONE] for 1–3 sec. to transmit a 1750 Hz tone call signal.

■ One-touch repeater (U.S.A. and Australia versions only)

The U.S.A. and Australia version's repeater settings (DUP+ or DUP– and tone encoder ON) can be activated by simply pushing [FM/RPT] in FM mode.

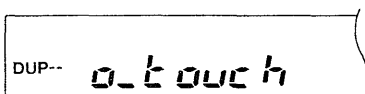

The display shows – duplex is selected to the one-touch repeater function.

The duplex direction setting is common for each band. Set the desired duplex direction as follows:

- ① Push [FUNC] then [TONE•SET] to enter set mode.
- ② Push [TONE] once to select the subaudible tone frequency setting display.
- ③ Rotate the tuning dial to select the desired duplex direction.
- ④ Push [CHECK] to exit the set mode.

Offset frequency

Frequencies can be independently set for each band. Set the desired offset frequency as follows:

Appears when 1 kHz or 1 MHz tuning step is selected.

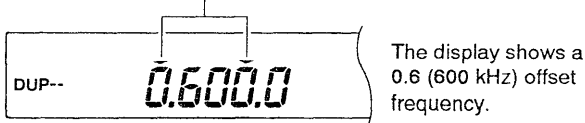

① Select the desired band as the main band with the [M/S] switch.

- ② Push [FUNC] then [TONE•SET] to enter set mode.
- ③ Push [TONE] twice to select the offset frequency setting display.
- ④ Rotate the tuning dial to select the desired frequency.
 - Selectable step increment is the same as the preset tuning step in FM mode. (p. 21)
 - 1 kHz tuning step is selected in SSB/CW mode.
 - Use [kHz/MHz] for quick frequency setting.
- ⑤ Push [CHECK] to exit the set mode.

Tone scan

By monitoring a signal that is being transmitted on a repeater input frequency, you can determine the tone frequency necessary to open a repeater. The tone scan can be used in the main band only and an optional UT-50 is required.

- ① Select FM mode with the [FM/RPT] switch.
- ② Set the desired frequency to be checked for a tone frequency. (e.g. repeater input frequency)
- ③ Activate the tone encoder or tone squelch.
- ④ Push [FUNC], then [SCAN] to start the tone scan.

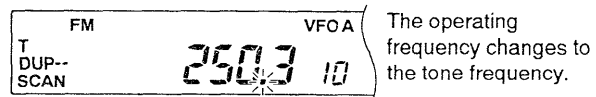

- ⑤ When the tone frequency is matched, the scan pauses with a beep and the tone frequency is programmed into the set mode contents of the subaudible tone or tone squelch frequency.
 - The tone frequency is temporally changed when scanning on a memory or call channel.
- ⑥ Push [SCAN] to stop the tone scan.
 - When the scan resume function is cancelled using the L-set mode the tone scan is cancelled when the tone frequency is matched. (p. 41)

Auto repeater function (U.S.A. and Australia versions only)

The U.S.A. and Australia versions automatically activate the repeater settings (DUP + or DUP – and tone encoder ON/OFF) when the operating frequency falls within the general repeater frequency range and deactivates them when outside of the range.

See p. 41 for auto repeater selection.

• Programming a repeater frequency range

The U.S.A. and Australia versions can have 3 repeater output frequency ranges set for each band. For the U.S.A. version, the general repeater frequency ranges (below) are set by default.

- ① Program the desired lower repeater output frequency edge and duplex direction (DUP – or DUP +) into memory channel 1. (p. 30)
- ② Program the desired higher repeater output frequency edge into memory channel 2.

- ③ Program the other frequency edges into memory channels 3/4 and 5/6 in a similar manner.
 - If you do not require more ranges, be sure that memory channel 3 and/or 5 are set to simplex.
- ④ Program the other band edges referring to ① – ③.
- ⑤ Turn power OFF, then turn power ON while pushing [FM/RPT] and [TONE] to program the ranges.

After programming, the memory channels can be changed and the ranges do not change if the contents are changed.

• Default repeater frequency ranges and offset directions of the U.S.A. version

FREQUENCY RANGE	DUPLEX DIRECTION
145.2000–145.4999 MHz	"DUP –" appears.
146.6100–146.9999 MHz	
147.0000–147.3999 MHz	"DUP +" appears.
442.0000–444.9999 MHz	"DUP +" appears.
447.0000–449.9999 MHz	"DUP –" appears.

Memory channels

The transceiver has a total of 100 memory channels. Each memory channel can be used to store often-used frequencies and operating modes as well as a tone frequency, offset frequency, etc.

50 channels are assigned to each band initially. However, these can be allocated between bands for a maximum of 80 channels in one band. (in this case, 20 channels for the other band).

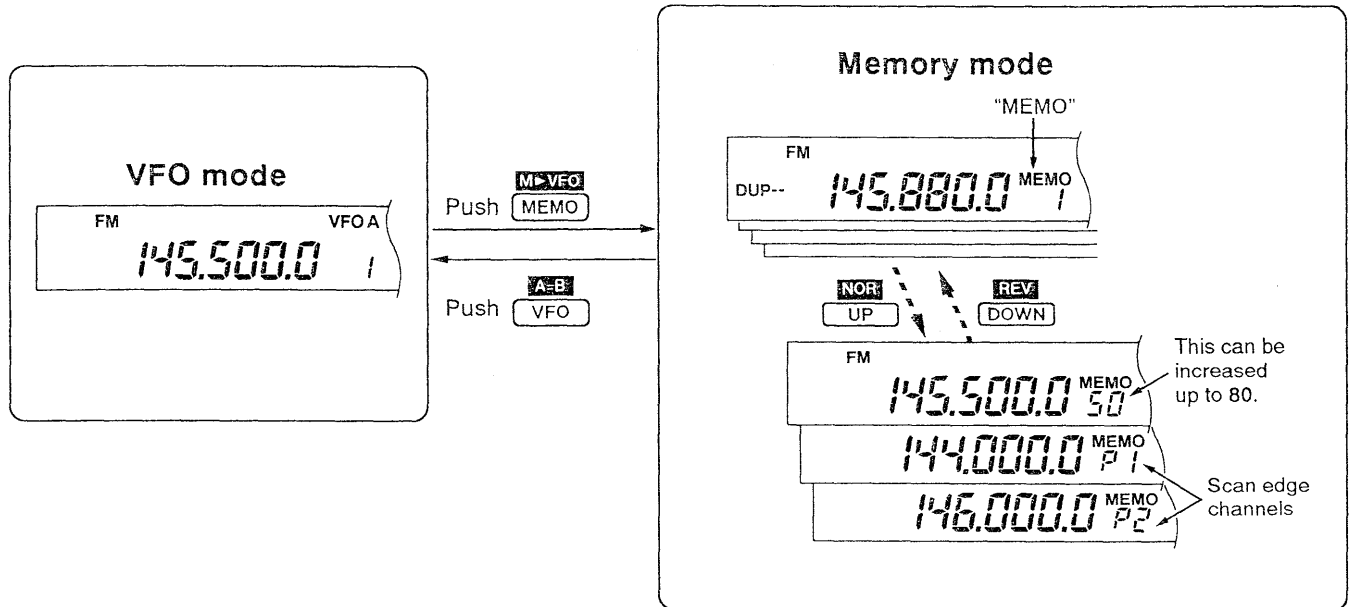

Operation on a memory channel

- Frequency and mode, etc. can be changed in a memory channel. However, they will be cleared if [MW] is not pushed.

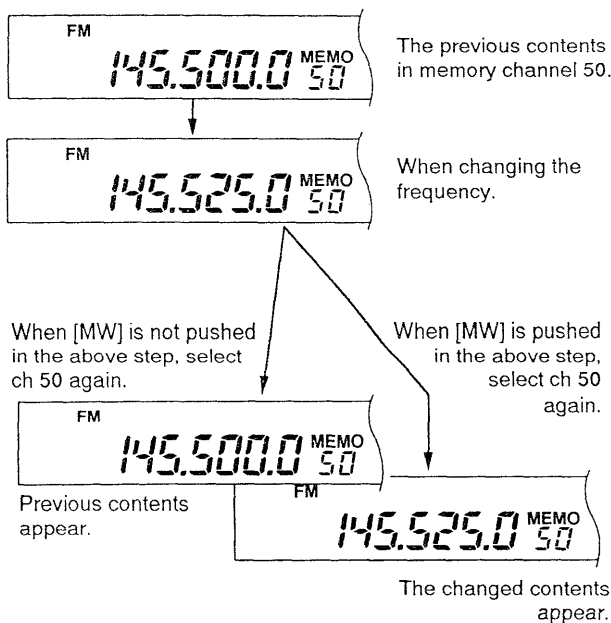

- Memory channel 6 and channels above have no contents programmed. The following indication appears after 2 sec. when selecting these channels.

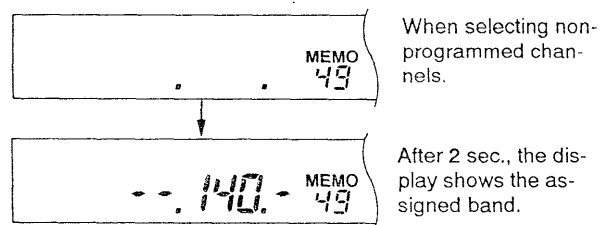

- A beep tone sounds when changing the memory channel. 2 beep tones sound when scan edge channels are selected to distinguish the end of the memory channels.

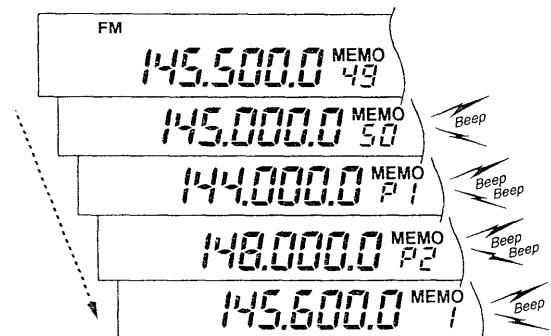

Memory channel selection

- ① Push [MEMO] to select the memory mode.
- "MEMO" appears.
- ② Push [DOWN] or [UP] to select the desired memory channel.
- The tuning dial can also be used for memory channel selection. While pushing [MEMO], rotate the tuning dial.
- ③ To return to the VFO mode, push [VFO].

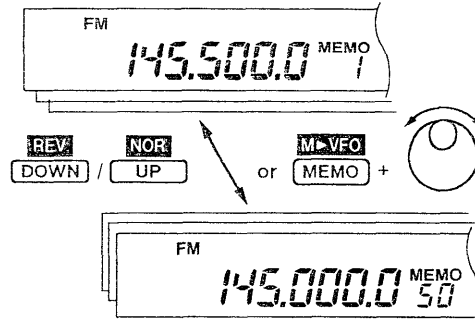

Memory channel programming

Memory channel programming can be performed either in the VFO mode or in the memory mode.

• Programming in the VFO mode

- ① Set the desired frequency and operating mode in the VFO mode.
- Tone frequency, offset frequency, etc., can also be programmed.
- ② Push [DOWN] or [UP] to select the desired memory channel to be programmed.
- The tuning dial can also be used while [MEMO] is pushed.
- ③ Push and hold [MW] for 2 sec. to program the displayed frequency and operating mode into the memory channel.

To check the programmed contents, push [MEMO] to select the memory mode.

[EXAMPLE]: Programming 144.275 MHz/USB into memory channel 12.

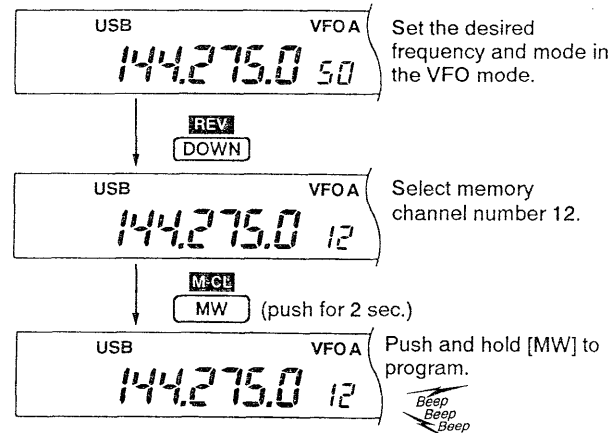

• Programming in the memory mode

- ① Push [MEMO] to select the memory mode.
- ② Select the desired memory channel to be programmed with the [DOWN] or [UP] switch.
- The tuning dial can also be used while [MEMO] is pushed.
- ③ Set the desired frequency and operating mode in the memory mode.
- Tone frequency, offset frequency, etc., can also be programmed.
- Blank channels cannot be programmed in the memory mode. Select the VFO mode in advance, then program blank channels.
- ④ Push and hold [MW] for 2 sec. to program the displayed frequency and operating mode into the memory channel.

[EXAMPLE]: Programming 145.750 MHz/FM into memory channel 18.

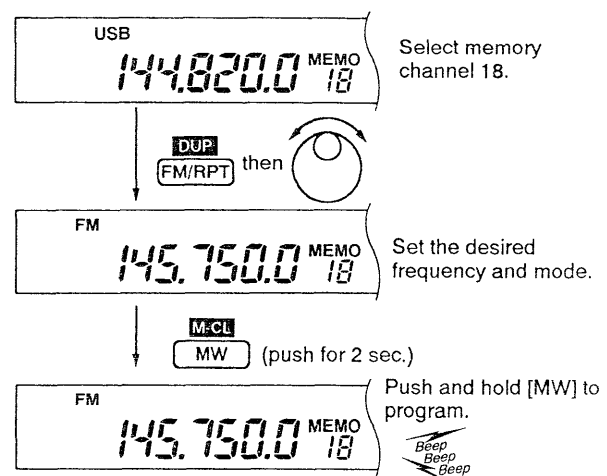

Transferring memory contents

This function transfers the memory channel contents into a VFO. This is useful to call up the subaudible tone frequency, offset frequency, etc., to the VFO.

NOTE: When you have changed the frequency and mode in the selected memory channel:
 - **Displayed** frequency/mode are transferred.
 - **Programmed** frequency/mode are not transferred, and they remain in the memory channel.

- ① Push [MEMO] to select the memory mode.
 - This function cannot be activated from the VFO mode.
- ② Select a memory channel with the [DOWN] or [UP] switch.
 - The tuning dial can also be used while [MEMO] is pushed.
- ③ Push [FUNC] then [MEMO•M▶VFO] for 2 sec. to transfer the contents of the memory channel.
 - The contents are transferred to the most recently used VFO (VFO A or VFO B).

TRANSFERRING EXAMPLE

Operating frequency : 144.028 MHz/CW (MEMO 19)
 Previously used VFO : VFO A

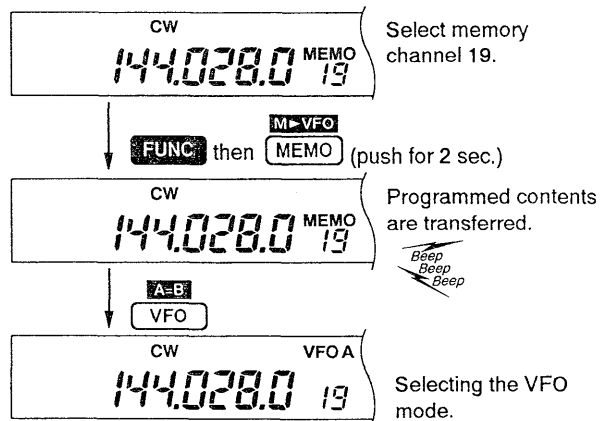

Memory clearing

Any unnecessary memory channels can be cleared. The cleared memory channels become blank channels.

- ① Push [MEMO] to select the memory mode.
- ② Select a memory channel to be cleared with the [DOWN] or [UP] switch.
- ③ Push and hold [FUNC] then push [MW•M-CL] for 2 sec. to clear the contents.
 - The programmed frequency and operating mode disappear.
- ④ To clear other memory channels, repeat steps ② and ③.

NOTE: Scan edge channels P1 and P2 cannot be cleared.

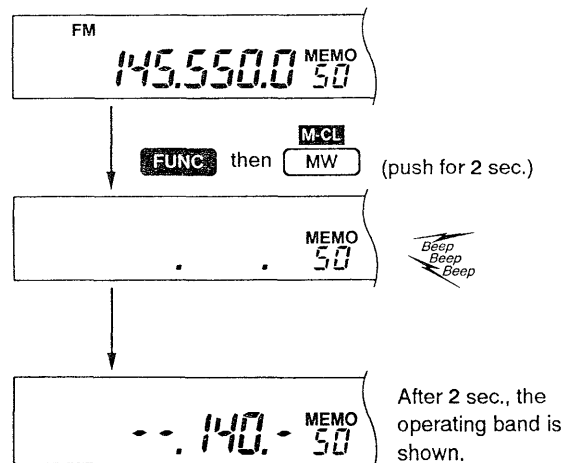

Scan edge channels

Scan edge channels, P1 and P2, are located between the highest memory channel (initially 50) and channel 1. When operating a programmed scan, the scan operates between these programmed frequencies.

Programming can be performed in the same manner as other memory channels.

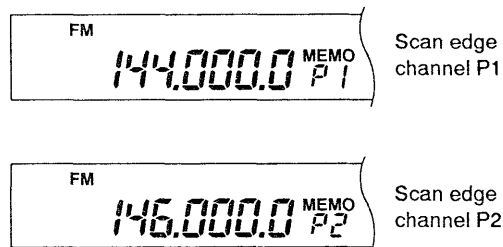

Memory channel allocation

The transceiver has a total of 100 memory channels. There are 50 channels for each band initially.

When you want more channels for a particular band, the number of memory channels can be allocated in 10 channel steps.

NOTE: Subtracted band memory channels will be cleared in 10-channel steps from the higher memory channels. Memory channels removed from a band have their contents erased. These removed contents cannot be recalled.

Allocation operation

- ① Turn the power OFF.
- ② While pushing [LOCK], turn power ON.
- The L-set mode is accessed.

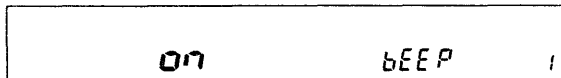
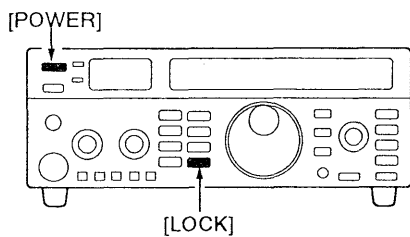

One of the L-set mode displays appears.

- ③ Push [DOWN] or [UP] to select the channel allocation display.

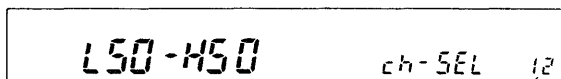

Channel allocation display

Select item 12

- ④ Rotate the tuning dial to select the desired number.

- "L" stands for the 144 MHz band
- "H" stands for the 430 MHz band.

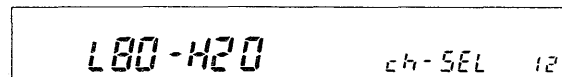

144 MHz band: 80 430 MHz band: 20

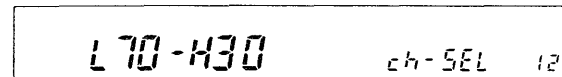

144 MHz band: 70 430 MHz band: 30

⋮

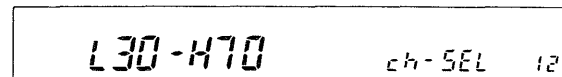

144 MHz band: 30 430 MHz band: 70

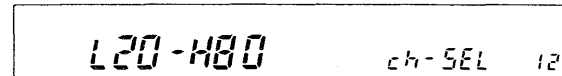

144 MHz band: 20 430 MHz band: 80

- ⑤ Push [POWER] to turn power OFF, then turn power ON again to exit the L-set mode.
- The selected allocation is programmed.

■ Call up a call channel

The call channel is a one-touch accessible channel for recalling your most-often-used frequency. The transceiver has one call channel for each band (a total of 2 channels).

• Calling up

- ① Select the desired band with the [M/S] or [SUB] switch.
- ② Push [CALL] to select the call channel.
- ③ To return to the previous display, push [VFO] or [MEMO].

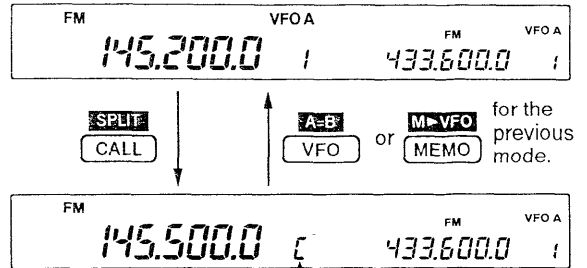

"C" appears when a call channel is selected.

■ Call channel programming

The following contents can be programmed into the call channel in the same way as a memory channel.

- Operating frequency
- Operating mode
- Duplex direction and its offset frequency
- Tone encoder or optional tone squelch and its tone frequency.

• Programming

- ① Select the desired band with the [M/S] or [SUB] switch.
- ② Push [CALL] to call up the call channel.
- ③ While pushing [CALL], rotate the tuning dial to set the desired frequency to be programmed into the call channel.
- ④ Select the desired operating mode with the [FM/RPT] or [SSB/CW] switch.
 - Set the tone frequency, offset frequency, etc., if desired.
- ⑤ Push and hold [MW] for 2 sec. to program.

[EXAMPLE]: Programming 145.50 MHz/FM into the call channel.

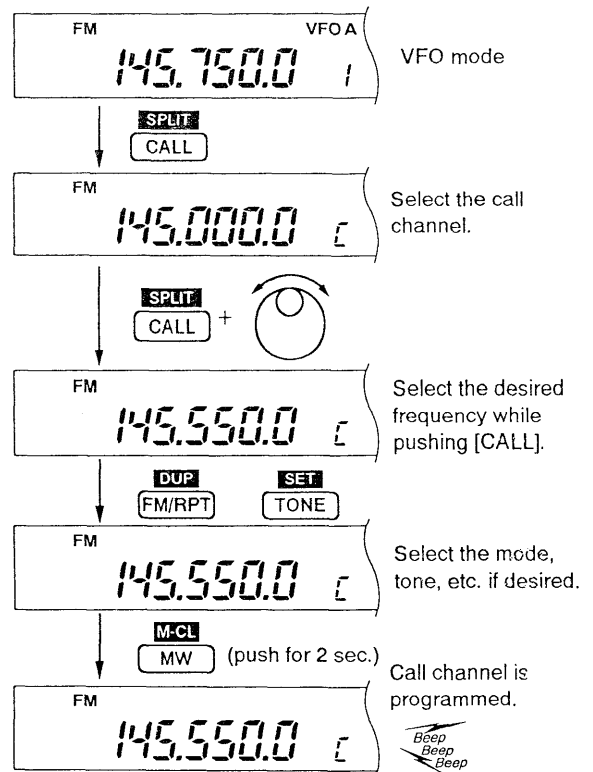

■ Satellite communications outline

Both satellite mode B (435 MHz uplink, 145 MHz downlink) and mode J (145 MHz uplink, 435 MHz downlink) can be operated from the IC-820H.

Satellite communications is possible only when a satellite is in view and its transponder is activated.

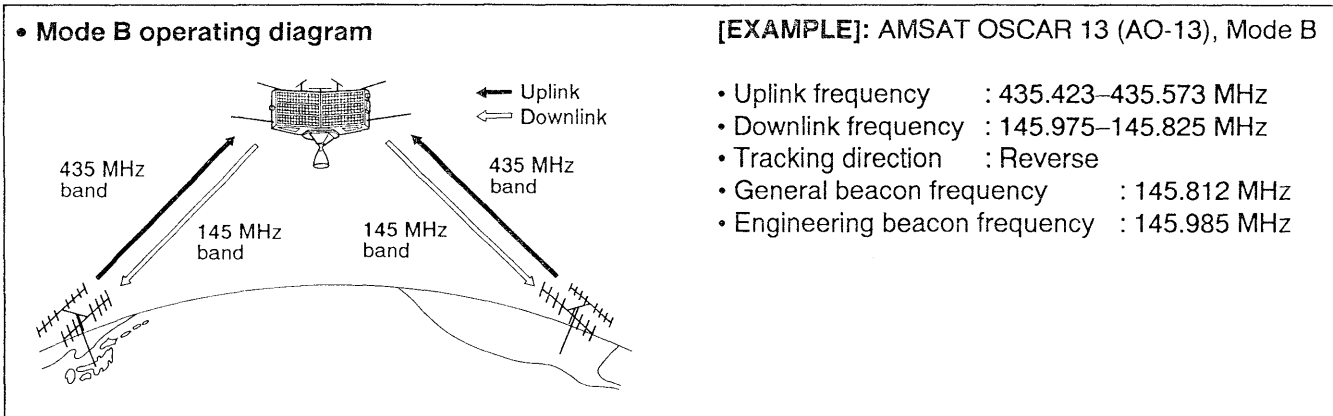

■ Panel description while in the satellite mode

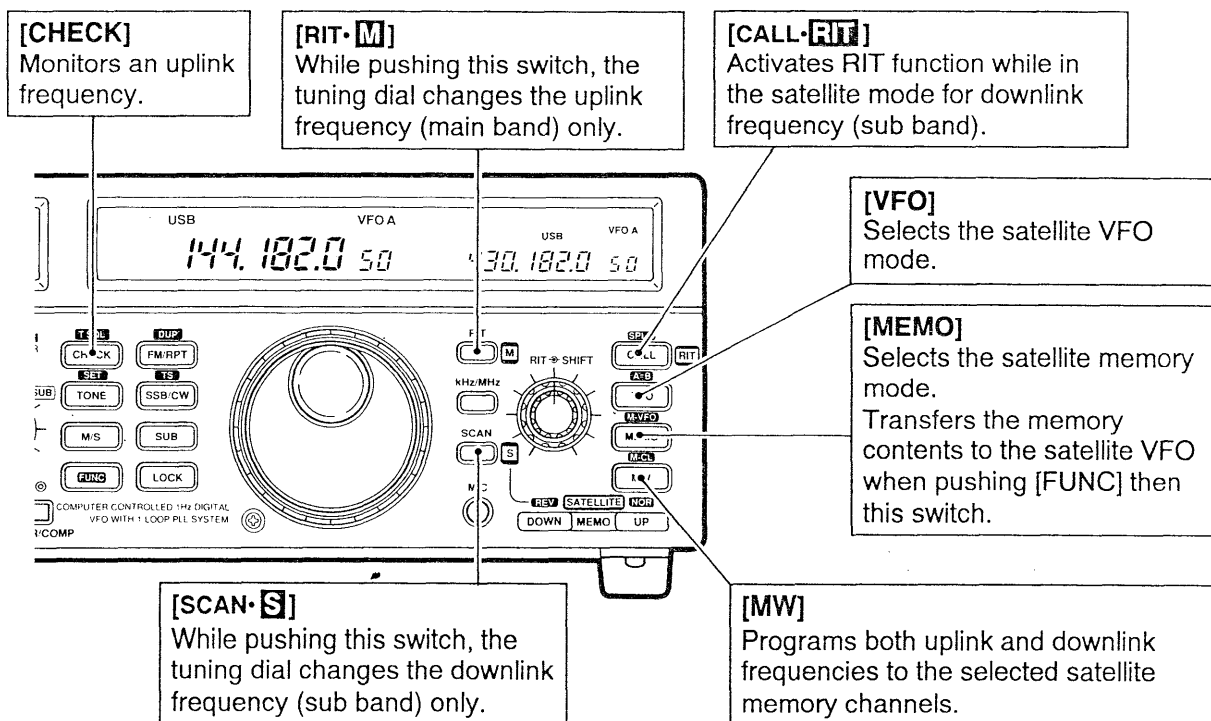

One of these appears to indicate a tracking direction of normal or reverse.

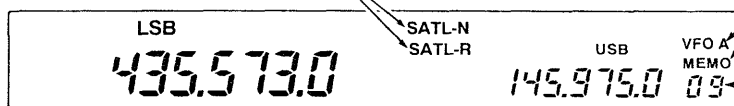

Uplink frequency
(transmit frequency)

Downlink frequency
(Receive frequency)

One of these appears to indicate the satellite VFO or satellite memory mode.

Satellite memory
channel number

Satellite notes

- NEVER set the output power too high. Too much power will shorten the satellite's life. Set your transmit power so that your downlink signal level is lower than the beacon's signal level.
- Confirm a satellite's operating mode in advance through documentation (magazines, etc.) or via appropriate satellite tracking software. In the wrong mode, you cannot use the satellite even if you receive its beacon signal.
- Preamplifiers may be necessary to receive satellite signals. Optional AG-25 and AG-35 are available to connect to the IC-820H (see p. 52).

- When you use a reverse tracking satellite in SSB mode, use LSB for the uplink frequency and USB for the downlink frequency.
 - When using a normal tracking satellite in SSB mode, use USB for both the uplink and downlink frequencies.

Pre-operation

- Decide on a usable satellite.
- Confirm the approximate location of the satellite and operating mode (e.g. "B," "J," etc.) through documentation (magazines, etc.) or via appropriate satellite tracking software.

Operation

- Set the antenna direction for the desired satellite.
- Select the satellite mode on the transceiver.
 - Push [FUNC] then [DOWN-REV] or [UP-NOR] to select reverse tracking or normal tracking, respectively. (Most satellites can be used with reverse tracking.)
 - When [DOWN-REV] or [UP-NOR] is pushed and held in the above step, the selected frequencies and modes can be used in the satellite VFO.

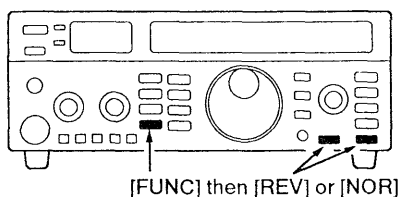

- Perform a loop test.
 - Set the downlink frequency (sub band) to an empty frequency within the satellite's coverage.
 - While pushing [RIT-M] and transmitting a single tone such as a whistle, set the uplink frequency (main band) to find your downlink signal and monitor your own signal correctly.

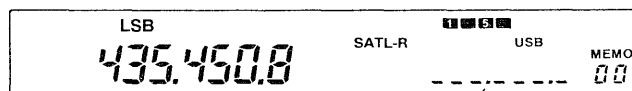

The sub band frequency disappears while pushing [RIT-M].

NOTE: To avoid excessive power, set the output power so that the downlink signal strength is lower than the beacon's strength.

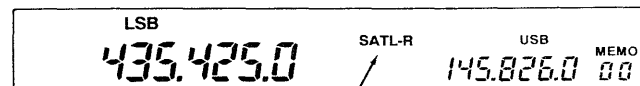

Appears when reverse tracking is selected.

- Select a mode on the transceiver.

Satellite	Uplink (main band)	Downlink (sub band)
Reverse tracking type	LSB (or CW)	USB (or CW)
Normal tracking type	USB (or CW)	USB (or CW)

Another operating mode may be required for digital mode operation.

- Set the downlink frequency (sub band) to the beacon frequency.
 - Refer to a ham magazine or book for detailed information.
 - Adjust the antenna direction so that the S-meter swings to its strongest level.
 - The S-meter level should be noted for transmit power selection during a loop test.

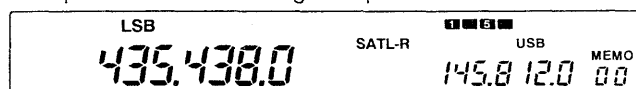

- Set the desired frequency to begin your satellite communications.
 - Both the downlink and uplink frequencies are changed simultaneously.
- When your downlink audio drifts (Doppler effect), adjust the uplink frequency (main band) only.
 - While pushing [RIT-M], rotate the tuning dial to change the uplink frequency only.
 - When a particular station's audio is off frequency, use the RIT function (push [CALL-RIT]).
- To exit satellite operation, repeat step ②.
 - Push [FUNC] then [DOWN-REV] or [UP-NOR].
 - The main and sub band frequencies can be transferred when pushing and holding [DOWN-REV] or [UP-NOR] on this step.

CONVENIENT: As the transceiver has 10 satellite memory channels, once set the desired satellites frequencies can be recalled instantly.

Satellite VFO and satellite memory

The transceiver has 1 satellite VFO and 10 satellite memory channels to memorize both uplink and downlink frequencies.

Memory programming and memory transferring can be performed in the same manner as normal memory mode operation.

SATELLITE VFO MODE

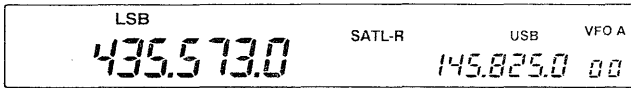

The satellite VFO mode records set frequencies and modes each time they change. Use the satellite VFO mode for finding satellites easily.

SATELLITE MEMORY MODE

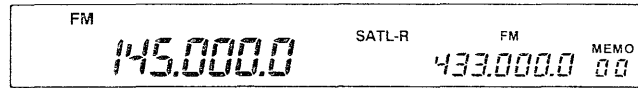

The satellite memory mode keeps programmed frequencies and modes until they are overwritten. These memory channels are convenient for programming data for individual satellites.

Satellite mode selection

When satellite mode is selected, a satellite memory channel or satellite VFO appears. When you have set frequencies in normal VFO mode, the set frequencies can be transferred to the satellite VFO.

To select the satellite VFO along with set frequencies:

- Push [FUNC], then push and hold [DOWN•REV] or [UP•NOR] for 2 sec.

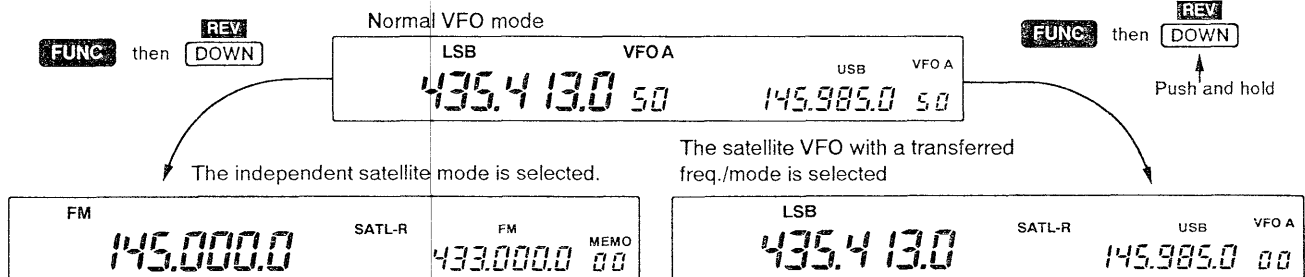

The satellite VFO with a transferred freq./mode is selected

The freq./mode selected in the satellite mode can also be transferred to normal VFOs in the same way.

Satellite memory programming

- ① Select the satellite mode.
- Push [FUNC] then push (or push and hold) [DOWN•REV] or [UP•NOR].
- ② Push [DOWN•REV] or [UP•NOR] to select the desired satellite memory channel.
- ③ Push [VFO] to select the satellite VFO mode if desired.
- Memory programming can be performed in both the satellite VFO and satellite memory modes.
- ④ Select the desired frequencies and modes for uplink and downlink.
- ⑤ Push and hold [MW] for 2 sec. to program the set contents to the satellite memory channel.

[EXAMPLE]: Programming 435.54 (LSB) / 145.88 (USB) into satellite memory channel 1.

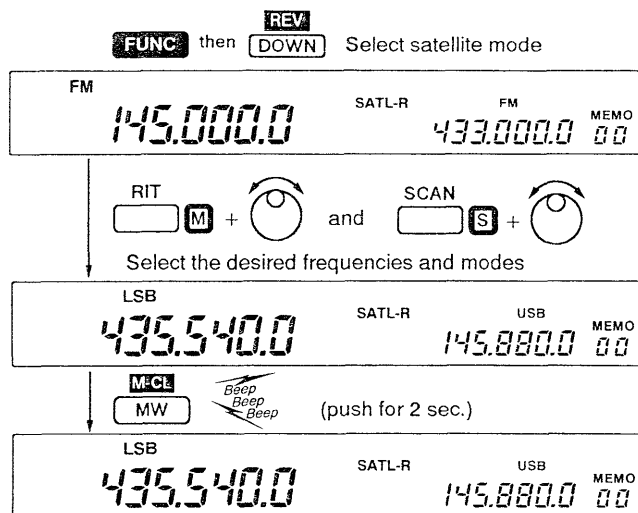

Scan types

The transceiver has 3 scan types providing tremendous scanning versatility at the touch of a few switches.

Select the scan which matches your operating needs for each band.

NOTE: The scan function can be used in the main band only.

MEMORY SCAN

Repeatedly scans all programmed memory channels.

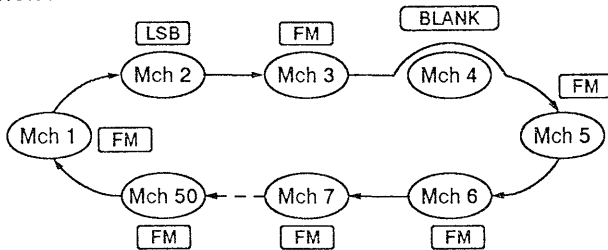

This scan operates in the memory mode.

PROGRAMMED SCAN

Repeatedly scans between two scan edge frequencies (scan edge memory channels P1 and P2).

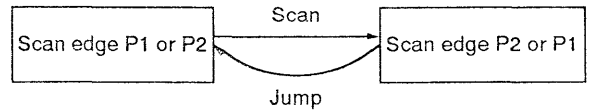

This scan operates in the VFO mode.

MODE SELECT MEMORY SCAN

Repeatedly scans memory channels having a specified mode.

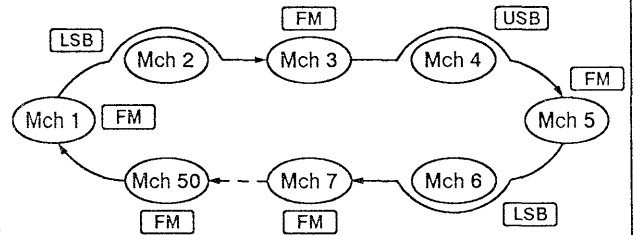

This scan operates in the memory mode.

Pre-operation

• Presetting

Program the memory channels before operating a scan as follows:

SCAN TYPE	REQUIRED PRESETTING
PROGRAMMED SCAN	Program scan edge frequencies into scan edge memory channels P1 and P2. (p. 31).
MEMORY SCAN	Program desired scan frequencies into 2 or more memory channels.
MODE SELECT MEMORY SCAN	Program desired scan frequencies with the same operating mode into 2 or more memory channels.

• Scan resume ON/OFF

You can set the scan to resume or cancel when detecting a signal. Scan resume ON/OFF must be set before operating a scan. See p. 41 for ON/OFF setting and scan resume condition details.

• Squelch condition

Before starting a scan, open or close the squelch for the desired operation as described below:

SCAN STARTS WITH	PROGRAMMED SCAN	MEMORY SCANS
SQUELCH OPEN	<ul style="list-style-type: none"> For FM mode, scan pauses (or cancels) on each frequency. For SSB/CW mode, scan continues regardless of the signal condition. 	Scan pauses on each channel when the scan resume is ON; not applicable when OFF.
SQUELCH CLOSED	Scan stops when detecting a signal. If you set scan resume to "ON" in the L-set mode, the scan pauses for 10 sec. when detecting a signal, then resumes. When a signal disappears while scan is paused, scan resumes 2 sec. later.	

• Scan speed

Scan speed can be selected from 2 levels, high or low, in the L-set mode. See p. 41 for details.

Programmed scan operation

- ① Push [VFO] to select the VFO mode.
- ② Select the desired operating mode.
- The operating mode can also be changed while scanning.
- ③ Set the main band's [SQL] open or closed.
- For FM mode, squelch must be closed.
- See page at left for scan condition.
- ④ Push [SCAN] to start the scan.
- "SCAN" appears while scanning.
- ⑤ When the scan detects a signal, the scan stops, pauses or ignores it depending on the resume setting and the squelch condition.
- During scan, the [kHz/MHz] switch can be used.
- ⑥ To cancel the scan, push [SCAN].

NOTE: If the same frequencies are programmed into the scan edge memory channels P1 and P2, programmed scan does not start.

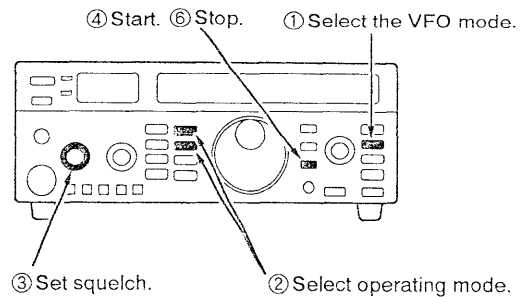

[DISPLAY EXAMPLE DURING A SCAN]

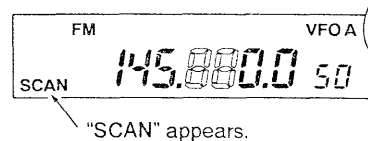

Memory scan operation

- ① Push [MEMO] to select the memory mode.
- ② Rotate the main band's [SQL] to close the squelch.
- ③ Push [SCAN] to start the scan.
- "SCAN" appears.
- ④ When the scan detects a signal, the scan stops or pauses depending on the scan resume setting.
- ⑤ To cancel the scan, rotate the tuning dial, or push [SCAN].

NOTE: 2 or more memory channels must be programmed for memory scan to start.

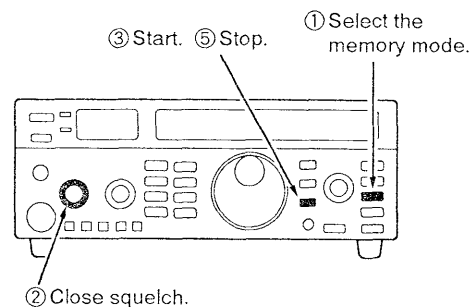

Mode select memory scan operation

- ① Push [MEMO] to select the memory mode.
- ② Select the desired mode (USB, LSB, CW or FM).
- ③ Rotate the main band's [SQL] to close the squelch.
- ④ Push [LOCK] as a pre-operation for the mode select memory scan.
- ⑤ Push [SCAN] to start the scan.
- While scanning, the "select mode" may be changed by pushing a mode switch, [FM] or [SSB/CW].
- ⑥ When the scan detects a signal, the scan stops or pauses depending on the scan resume setting.
- ⑦ To cancel the scan, rotate the tuning dial, or push [SCAN].

NOTE: 2 or more memory channels must be programmed with the same operating mode for select memory scan to start.

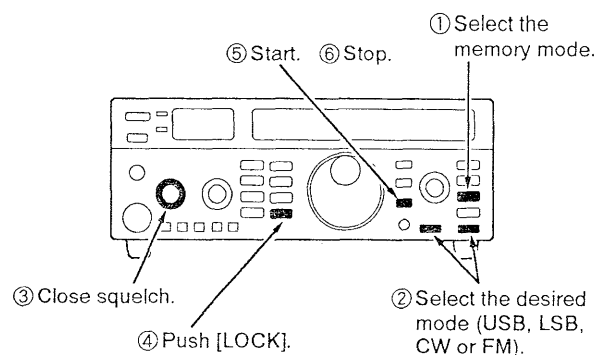

12 SET MODE

■ Set mode description

The transceiver has an F-set mode and an L-set mode for 20 items in total for the 2 modes:

• Set mode operation

- ① Push OUT [POWER] to turn power OFF.
- ② While pushing [FUNC] or [LOCK], push [POWER] IN to turn power ON.
 - [FUNC] for F-set mode.
 - [LOCK] for L-set mode.
- ③ Push [UP] or [DOWN] several times until the desired item appears.
- ④ Rotate the tuning dial to set the values or conditions for the selected item.
- ⑤ Repeat steps ③ and ④ to set other items.
- ⑥ After all desired items are set, push [POWER] OUT to turn power OFF.
- ⑦ Push [POWER] IN to turn power ON.
 - Now the set values or conditions are effective.

When you want to set an item to its default setting (initialized condition), push [MW•M-CL] after selecting the desired item.

Turn power ON while pushing one of the switches below.

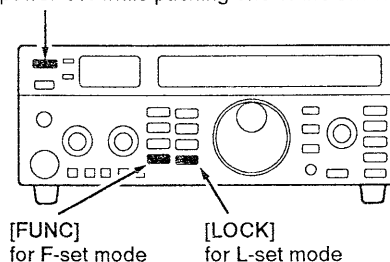

[DISPLAY EXAMPLE IN THE SET MODE]

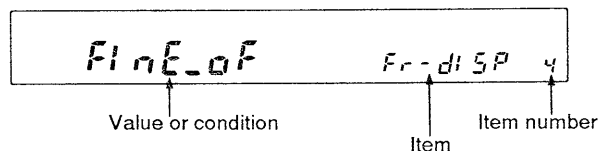

■ F-set mode

(1) Display intensity "dISP"

The display backlight can be set to one of 2 intensity levels. Choose a level suitable for your operating environment.

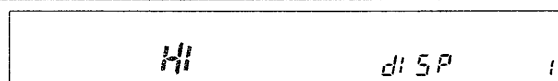

High (default)



Low

(2) Attenuator activation "Att"

When [ATT] is pushed, the attenuator circuits in both the 144 and 430 MHz bands activate. When only 1 band requires the attenuator, such as for an interfering electrical field in your area, the [ATT] switch's function can be specified for the desired band only.



Attenuator activates for both 144 and 430 MHz bands (default)

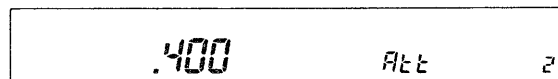

Attenuator activates for 430 MHz band only



Attenuator activates for 144 MHz band only

(3) External preamplifier selection "PrE"

When optional external preamplifiers (mast-mount type), AG-25 (144 MHz) and AG-35 (430 MHz) are connected to the transceiver's antenna connectors, set this item according to the connected preamplifiers.

This setting applies DC voltage to antenna connectors while receiving, therefore, the selection must be OFF when no preamplifier is connected.

140.400 PrE 3
 Preamps connected to both bands (default)

.400 PrE 3
 Preamp connected to 430 MHz band only

140. PrE 3
 Preamp connected to 144 MHz band only

off PrE 3
 No preamp is connected.

(4) CW break-in "br-In"

CW break-in function toggles transmit and receive with CW keying. When "off" is selected, push [TRANSMIT] IN to transmit manually before keying.

Adjust the [DELAY] control on the rear panel for switching times from transmit to receive when break-in is set to "ON."

on br-In CW 4
 CW semi break-in (default)

off br-In CW 4
 CW manual T/R switching

(5) FM center indicator "CEntEr"

When the received signal is off-center in FM mode, the green receive indicator blinks. When you desire no such indication, set this item to "off" to deactivate the center indicator function.

on FM CEntEr 5
 FM center indicator ON (default)

off FM CEntEr 5
 FM center indicator OFF

(6) Sub band S-meter "Sub-S"

When receiving a signal on the sub band, the S-meter in the function display shows the received signal strength. If you do not desire S-meter indication on the sub band, it can be deactivated.

on Sub-S 6
 Sub band S-meter ON (default)

off Sub-S 6
 Sub band S-meter OFF

(7) Sub band audio during transmit "Audio"

When transmitting on the main band, the sub band's sensitivity is decreased. At this time, sub band audio can be muted automatically.

on SUB Audio 7
 Sub band audio is output while transmitting (default)

off SUB Audio 7
 Sub band audio is muted while transmitting

(8) Automatic repeater setting "AutorPt"

(U.S.A. and Australia* versions only)

Repeater frequency coverage is usually fixed depending on your area of operation. When selecting a frequency within the frequency coverage, the transceiver can set to select duplex automatically if desired. Also, the subaudible tone encoder can be turned ON together with the duplex setting.

*Pre-programming of a repeater range is necessary for the Australia version.

off *AutorPt 8*
Automatic repeater selection OFF (default)

1 *AutorPt 8*
Duplex as the automatic selection

2 *AutorPt 8*
Duplex and tone as the automatic selection

L-set mode

(1) Confirmation beep "bEEP"

Low tone and high tone confirmation beeps sound each time a switch for the main band or sub band is pushed. Confirmation beeps can be turned OFF for silent operation.

on *bEEP 1*
Confirmation beep ON (default)

off *bEEP 1*
Confirmation beep OFF

(2) Scan resume "SC-rES"

When receiving a signal during a scan, scan pauses 10 sec., then restarts even when continuing to receive the signal. When you want to cancel a scan after receiving a signal, set this item to "oFF."

on *SC-rES 2*
Scan resumes (default)

off *SC-rES 2*
Scan is canceled

(3) Scan speed "SC-SPd"

The transceiver has 2 speeds for scanning, high and low.

Hi *SC-SPd 3*
High speed (default)

Lo *SC-SPd 3*
Low speed

(4) Fine tuning indication "Fr-diSP"

While rotating the tuning dial, the memory channel readout shows 10 Hz and 1 Hz digits instead of the memory channel number. This indication can be turned OFF if desired.

When turning the 10/1 Hz indication OFF, the tuning resolution remains at the specified value.

FinE_on *Fr-diSP 4*
1 Hz indication ON (default)

FinE_off *Fr-diSP 4*
1 Hz indication OFF

(5) RIT variable range (SSB/CW) "rit"

The variable range of the RIT function for SSB/CW mode can be set to the following values:

- ±0.1 kHz (100 Hz) ... tuning resolution: 1 Hz
- ±1 kHz tuning resolution: 10 Hz
- ±2 kHz tuning resolution: 20 Hz



±0.1 kHz range / 1 Hz steps



±1 kHz range / 10 Hz steps (default)

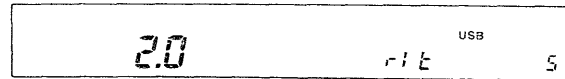

±2 kHz range / 20 Hz steps

(6) RIT variable range (FM) "rit"

The variable range of the RIT function for FM mode can be set separately from SSB/CW mode to the following values:

- ±1 kHz tuning resolution: 10 Hz
- ±5 kHz tuning resolution: 50 Hz
- ±10 kHz tuning resolution: 100 Hz



±1 kHz range / 10 Hz steps



±5 kHz range / 50 Hz steps (default)



±10 kHz range / 100 Hz steps

(7) Sub tuning dial function "SubdIAL"

The sub tuning dial function tunes a frequency without the tuning dial. This function can be assigned to the [RIT] or [SHIFT] control to suit your operating preference.

When assigning this function to the [RIT] control, the "RIT" indicator in the function display blinks during operation.



Sub dial function OFF



For the sub band with the [RIT] control (default)



For the accessed band with the [RIT] control



For the sub band with the [SHIFT] control



For the accessed band with the [SHIFT] control

(8) Optional voice synthesizer "SPEECH"

When an optional UT-36 VOICE SYNTHESIZER UNIT is installed the selected frequency, mode and selected VFO or memory channel are announced when the lock function is activated.

When you want to cancel the announcement without removing the UT-36, for silent operation, set this item to "OFF."



Optional voice synthesizer ON (default)

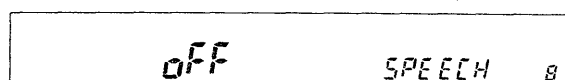

Optional voice synthesizer OFF

(9) CI-V address "CI-Addr"

The IC-820H has the address of 42H (66) as its default value.

If you want to designate a different address for your IC-820H, select the desired address in the range from 1H (1) to 7FH (127).

- Figures marked with an H are hexadecimal and bracketed figures () are decimals.



Address of 42H (IC-820H default)



Address of 7FH

(10) CI-V baud rate "CI-bAud"

Baud rate is the data transfer rate. The standard baud rate for the Icom CI-V is 1200 bps.

If you want to change the baud rate, rotate the tuning dial to select the desired baud rate from 300 bps, 1200 bps, 4800 bps or 9600 bps.



1200 bps (CI-V standard, default)



9600 bps

(11) CI-V transceive "CI-trn"

Transceive operation is possible with the IC-820H connected to other Icom transceivers or receivers.

When "on" is selected, changing the operating frequency, operating mode, etc. on the IC-820H automatically changes those of connected transceivers (or receivers) and vice versa.



Transceive ON (default)



Transceive OFF

(12) Memory channel allocation "ch-SEL"

The transceiver has a total of 100 regular memory channels for the 144 MHz and 430 MHz bands combined. The default in number of memory channels is set as 50 for each band.

When you desire more memory channels on a particular band, the assignment can be changed in step of 10 and up to 80 memory channels can be allocated to one band.

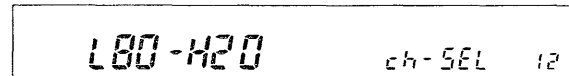

144 MHz band: 80 430 MHz band: 20

⋮

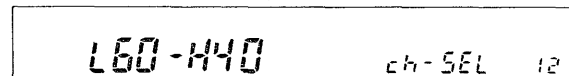

144 MHz band: 60 430 MHz band: 40

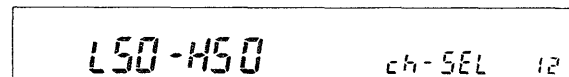

144 MHz band: 50 430 MHz band: 50 (default)

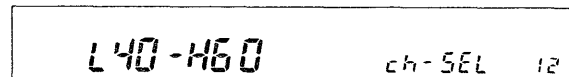

144 MHz band: 40 430 MHz band: 60

⋮

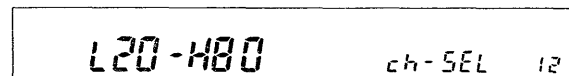

144 MHz band: 20 430 MHz band: 80

Opening the transceiver's case

Follow the case and cover opening procedures shown here when you want to install an optional unit or adjust the internal units, etc.

CAUTION: DISCONNECT the DC power cable from the transceiver before performing any work on the transceiver. Otherwise, the transceiver may be damaged.

- ① Remove 8 screws from the transceiver's top and 4 screws from the sides, then lift up the top cover.
- ② Turn the transceiver upside down.
- ③ Remove 4 screws from the bottom cover, then lift up the bottom cover.
- ④ Now you can see the MAIN unit.

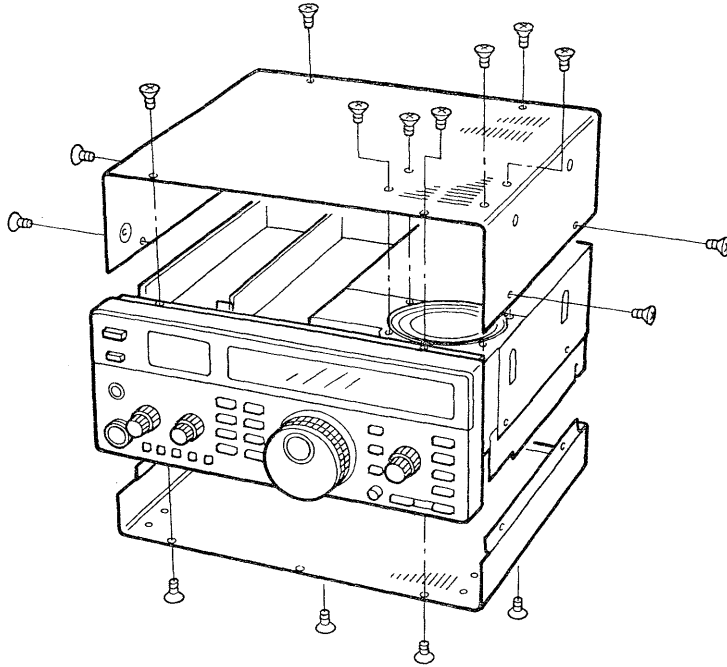

Opening the inside chassis

- ① Remove the top and bottom covers as shown above.
- ② Loosen the gutter screw on each side of the front panel's rear side.
- ③ Remove 1 screw from each side of the front panel's rear side.
- ④ Pull the front panel forward as shown by the arrow at right.
- ⑤ Loosen 1 flat head screw from each side of the MAIN unit chassis.
- ⑥ Remove the 2 silver screws from the rear panel.
- ⑦ Lift up the MAIN unit chassis to see the PLL unit.
- ⑧ Tighten the screws (labelled ⑤) to fix the MAIN unit chassis in a vertical position.

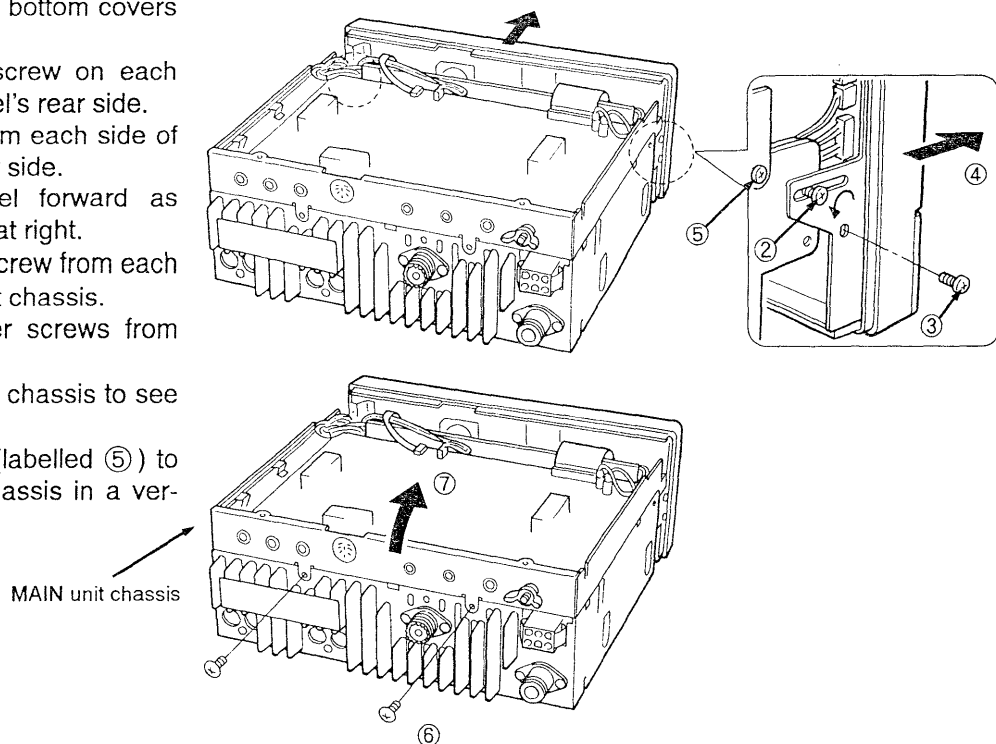

■ UT-50 TONE SQUELCH UNIT

The UT-50 TONE SQUELCH UNIT allows you to operate the tone squelch and tone scan. 2 units can be installed in the transceiver if you want to use these functions simultaneously on both the main and sub bands.

- One unit is sufficient for alternate operation of these functions on each band.

- ① Remove the top and bottom covers as described on p. 44.
- ② Plug UT-50(s) to J20 or J21 on the MAIN unit as shown at right.
- When installing one unit, either connector is OK.
- ③ After installing the unit(s), replace the top and bottom covers.

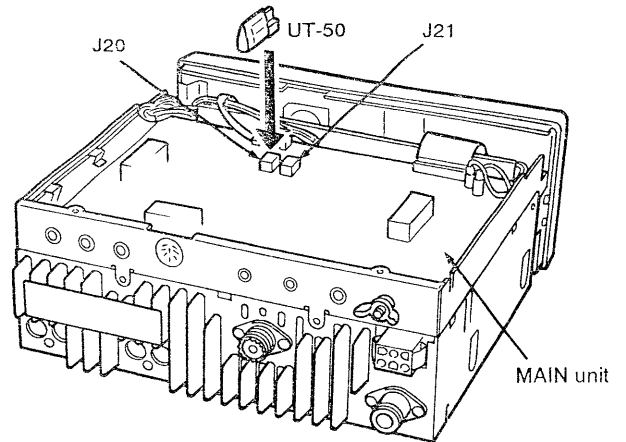

■ FL-132 CW NARROW FILTER

The transceiver has a CW-Narrow mode to provide better S/N (signal-to-noise), or to reject nearby interference. To use the CW-Narrow mode, an optional CW narrow filter is necessary.

NOTE: The CW-Narrow mode is available for the main band only, therefore, satellite operation (sub band for downlink) cannot be selected in CW-Narrow mode.

FILTER	Passband width	
	at -6 dB	at -60 dB
Built-in filter	2.3 kHz	4.2 kHz
FL-132	500 Hz	1.34 kHz

- ① Remove the top and bottom covers as described on p. 44.
- ② Remove 14 screws from the MAIN unit as shown at right.
- ③ Slide the MAIN unit forward slightly to free the ACC socket from the rear panel.
- ④ Lift up the MAIN unit from the rear panel side.
- ⑤ Install the FL-132 in the proper position.
- ⑥ Cut the filter leads, keeping 2-3 mm leads from the bottom of the MAIN unit.
- ⑦ Solder the leads.
- ⑧ Replace the MAIN unit and top/bottom covers.

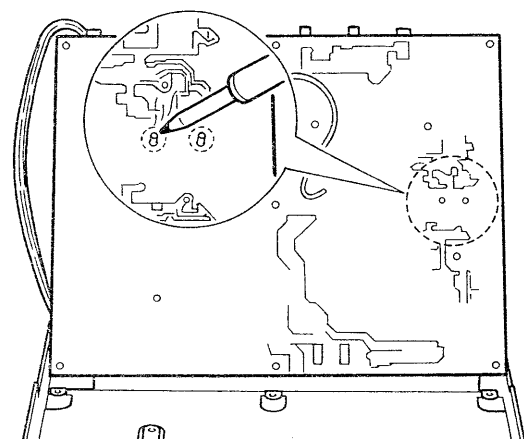
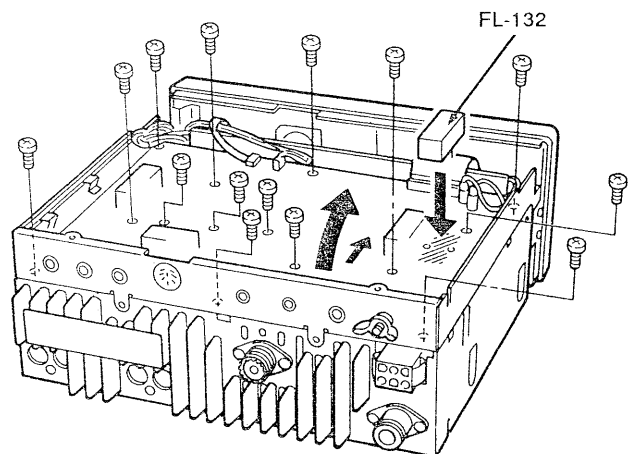

■ UT-36 VOICE SYNTHESIZER UNIT

The UT-36 announces the accessed band's frequency, mode, etc. in a clear, electronically-generated voice, in English (or Japanese).

- ① Remove both the top and bottom covers. (p. 44)
- ② Open the MAIN unit chassis. (p. 44)
- ③ Remove the protective paper attached to the bottom of the UT-36 to expose the adhesive strip.
- ④ Attach the UT-36 to the rear of the speaker as shown in the diagram at right.
- ⑤ Set the language, speech speed and speech level as shown in the diagram at right.
- ⑥ Replace the MAIN chassis and top/bottom covers.

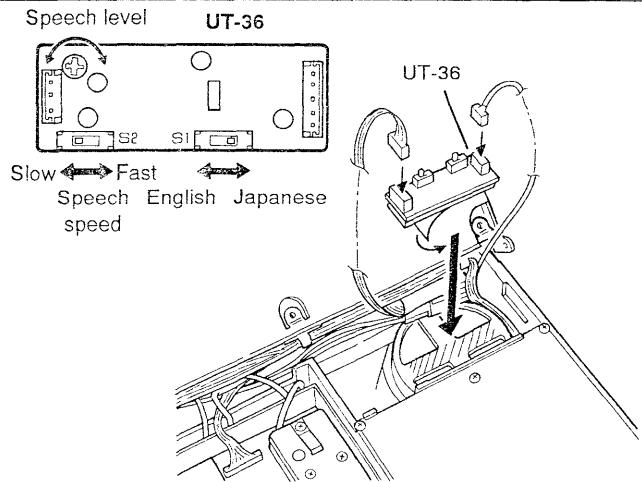

■ CR-293 HIGH STABILITY CRYSTAL UNIT

A temperature-compensating crystal with a stability of ± 3 ppm is built-in to the transceiver. For more demanding operation, such as during transverter use, etc., the CR-293 HIGH-STABILITY CRYSTAL UNIT is available. It has a stability of ± 0.5 ppm.

- ① Remove both the top and bottom covers. (p. 44)
- ② Open the MAIN unit chassis. (p. 44)
- ③ Remove the shield cover from the PLL unit. (Fig 1)
- ④ Remove 7 screws from the PLL unit, then lift up the PLL unit to expose the bottom side of the unit. (Fig 2)
- ⑤ Unsolder the 3 points of the built-in crystal's lead on the bottom of the PLL unit and the 1 point on the top of the PLL unit.
- Use a desoldering braid.
- ⑥ Replace the built-in crystal with the CR-293 and solder the leads of the CR-293.
- ⑦ Replace the PLL unit and the 7 screws.
- ⑧ Fit the wires from the rear of the front panel in the open space between the chassis and PLL unit. (Fig 3)
- Otherwise, the wires will be pinched by the PLL unit cover and the transceiver may be damaged.
- ⑨ Replace the PLL unit cover, MAIN unit chassis, and top/bottom covers.

NOTE: The CR-293 is an oven-type crystal unit, and specified frequency stability described above are guaranteed 1 min. after power ON.

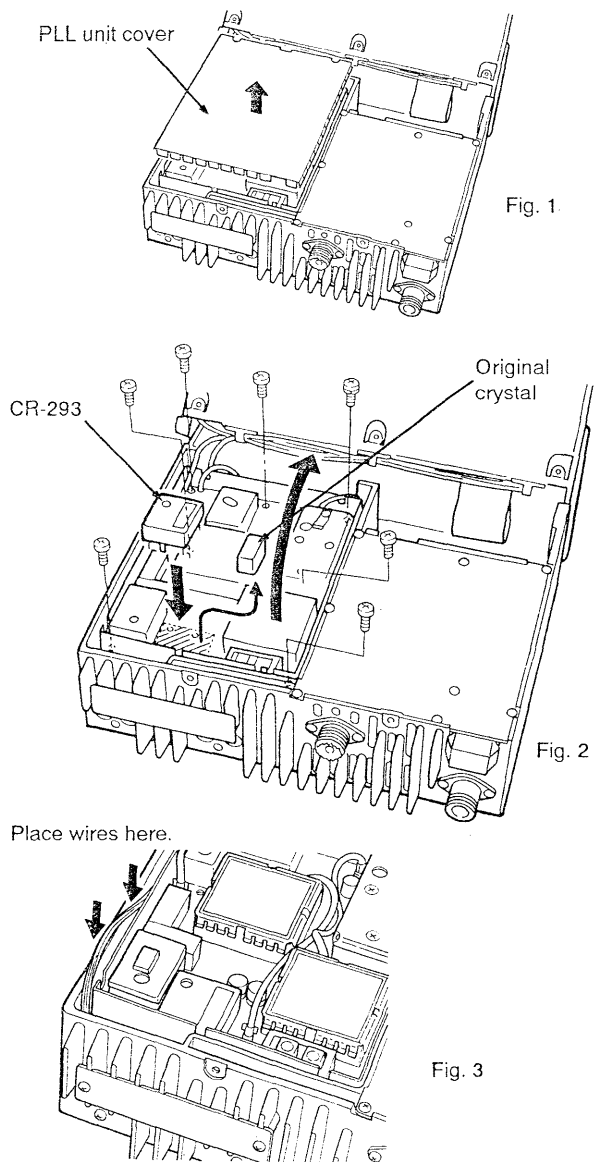

14 ADJUSTMENTS

Internal selections

The MAIN unit has 6 selectable switches to match your desired operation and for connecting external equipment.

To perform these selections, unplug the DC power cable and read "Opening the transceiver's case" on p. 44.

• HEADPHONES AUDIO

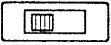
SEPA  MIX
Separate output Mixed output

The headphones' audio output can be set for a mix of main and sub band audio or for separated main and sub band channels when using stereo headphones.

- Initial setting: Separate output

• MODULATION INPUT SENSITIVITY

HIGH  LOW
Input level: 2 mV Input level: 100 mV

Selects the input sensitivity level. This selection is ignored when "PACT" (9600 bps) in "Baud rate selection" is selected.

- Initial setting: LOW (100 mV)

• COMPRESSOR LEVEL

The speech compressor function increases the average talk power level during SSB operation.

Adjust the trimmer control to get adequate compression level but no distortion while monitoring your transmitted voice signal with another V/UHF all mode transceiver.

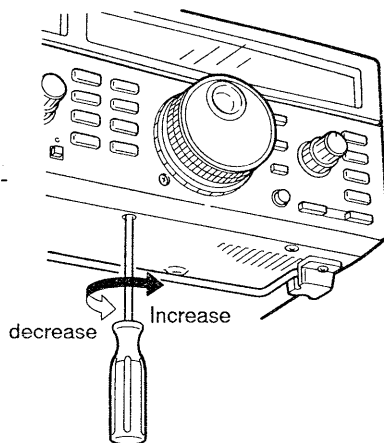

• CW SIDE TONE LEVEL

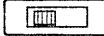
FIX 

CW side tone level is controlled by [CW SIDE TONE] only.

CW side tone level varies with [CW SIDE TONE] and [AF] on the front panel.

The [CW SIDE TONE] control on the rear panel controls the CW side tone level. This setting determines whether the output level is controlled by the [CW SIDE TONE] control only or is related to the [AF] control.

- Initial setting: Fixed level (regardless of the [AF] control)

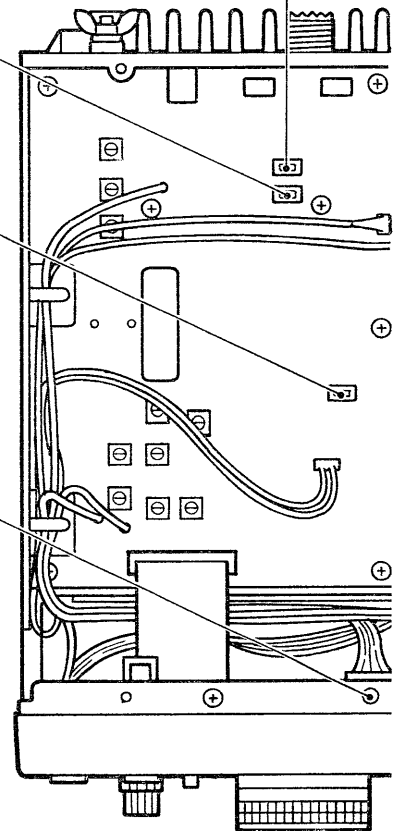

• **BAUD RATE SELECTION**

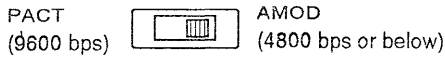

The transceiver can accept up to 9600 bps data communication. When "PACT" (9600 bps) is selected:

- External modulation input is applied to the modulation circuit directly.
- When the modulation level exceeds 1.6 V p-p, a modulation limiting circuit stops the modulation.
- At this time, only the carrier signal is transmitted and the [TX] indicator darkens.
- AF received signals are output from the ACC(1) socket regardless of the squelch condition.

When AMOD (below 4800 bps) is selected:

- Received AF signals are output from the ACC(1) socket when the squelch opens.

• Initial setting: AMOD

• **BAND SELECTION FOR AF/SQUELCH OUTPUT**

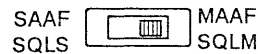

Sub band AF and sub band squelch signal output from the ACC(1) socket.

Main band AF and main band squelch signal output from the ACC(1) socket.

The ACC(1) socket pins 5 and 6 output AF detected signals and squelch signals respectively.

This switch selects which band (main or sub) is output from the ACC(1) socket.

• Initial setting: MAAF SQLM (main band)

• **ALC AND FREQUENCY UP/DOWN INPUT SELECTION**

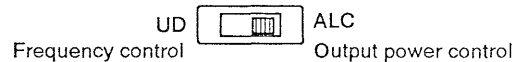

The ACC(1) socket pin 8 is an input/output selection port.

When ALC is selected:

- Transmitter output power can be controlled when applying a minus voltage of 0 to -4 V.
- The terminal voltage increases when low output power is selected with the [PWR/COMP] switch.

When UD is selected:

- The accessed band's frequency or memory channel can be controlled as well as the microphone's [UP]/[DOWN] switches.

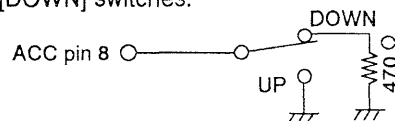

• Initial setting: ALC

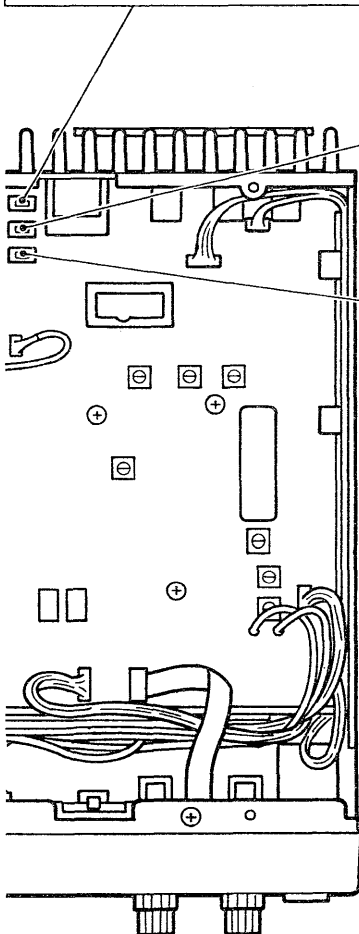

Internal views

• MAIN UNIT

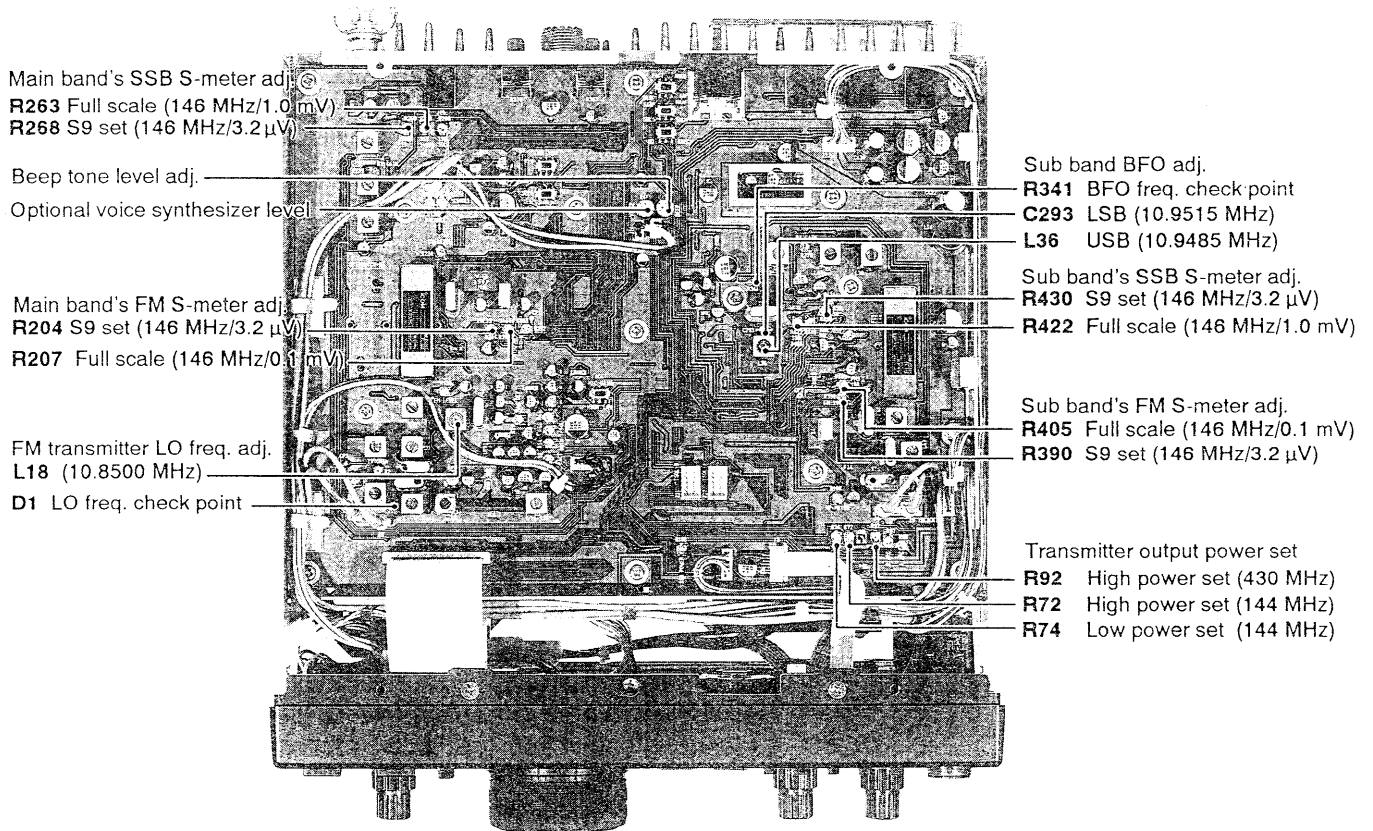

• RF AND PA UNITS

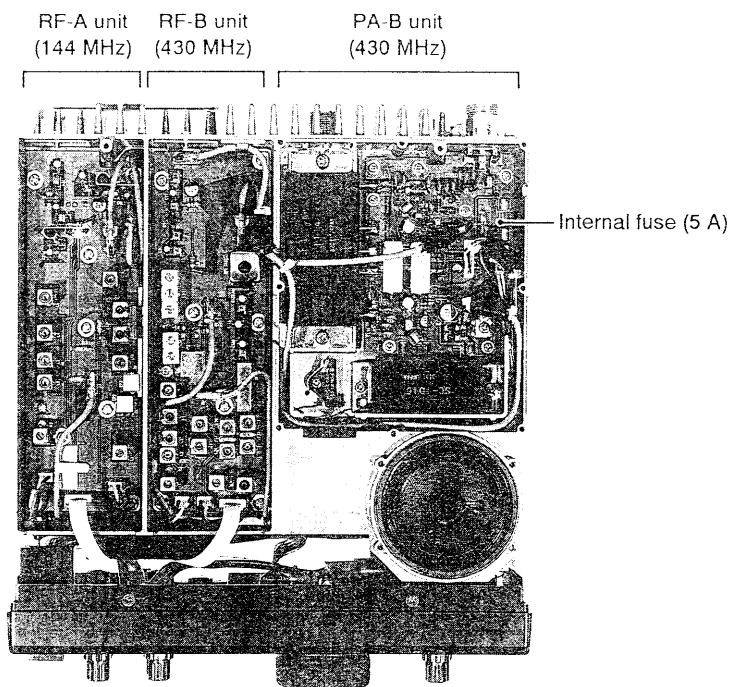

■ Troubleshooting

	PROBLEM	POSSIBLE CAUSE	SOLUTION	REF.
POWER	Power does not come on when [POWER] is pushed IN.	<ul style="list-style-type: none"> • Fuse is blown. • DC power cable is improperly connected. 	<ul style="list-style-type: none"> • Check for the cause, then replace the fuse with a spare one. (Fuses are installed in two places, in the DC power cable and in the PA unit.) • Reconnect the power cable correctly. Also, check the fuse in the DC power cable. 	See below p. 49 p. 12
	No sound comes from the speaker.	<ul style="list-style-type: none"> • The squelch is closed. • An optional tone squelch is in use. • CW-narrow mode is selected when an optional CW-narrow filter is not installed. 	<ul style="list-style-type: none"> • Rotate [SQL] counterclockwise to open the squelch. • Turn OFF the tone squelch to monitor all signals. • Select another mode. 	p. 17 p. 26 p. 18
RECEIVE	Sensitivity is low	<ul style="list-style-type: none"> • The attenuator is turned ON. • The VHF antenna is connected to the UHF antenna connector and vice versa. 	<ul style="list-style-type: none"> • Turn OFF the [ATT] switch. • Check the antennas and antenna connections. 	p. 23 p. 11
	Preamplifier does not function.	<ul style="list-style-type: none"> • An optional preamplifier is not connected. • Preamplifier is set to OFF in the F-set mode. 	<ul style="list-style-type: none"> • Connect an optional AG-25 (144 MHz) or AG-35 (430 MHz) if needed. • Set to ON for the preamplifier connected band. 	pgs. 13, 52 p. 40
TRANSMITTER	Transmitting is not possible.	<ul style="list-style-type: none"> • The [MIC] control is set too far counterclockwise when operating in SSB mode. 	<ul style="list-style-type: none"> • Set the [MIC] control to the center position. 	p. 25
	Output power is low.	<ul style="list-style-type: none"> • The VHF antenna is connected to the UHF antenna connector and vice versa. • Low power is selected. 	<ul style="list-style-type: none"> • Check the antennas and antenna connections. • Select the high power with [PWR/COMP]. - Make sure [PWR/COMP] functions as the power selection in the set mode. 	p. 11 pgs. 25, 26
DISPLAY	Frequency cannot be set.	<ul style="list-style-type: none"> • The call channel is selected. • The lock function is activated. 	<ul style="list-style-type: none"> • Select the VFO or memory mode. • Turn OFF the lock function. 	p. 33 p. 22
	Frequency is automatically changed.	<ul style="list-style-type: none"> • Sub tuning dial function is activated. 	<ul style="list-style-type: none"> • Turn OFF the sub tuning dial function or set the [RIT] or [SHIFT] control to the center. 	p. 22

■ Fuse replacement

If the fuse blows or the transceiver stops functioning, find the source of the problem if possible, and replace the damaged fuse with a new, rated fuse.

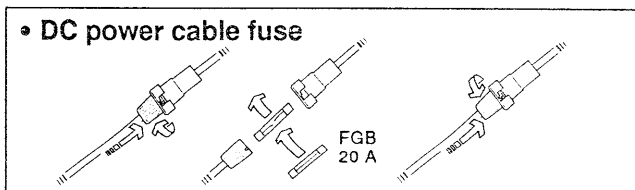

• Internal fuse

An internal fuse is installed on the line affecting all circuits except the V/UHF PA circuits. The fuse is located in the PA-B unit. See the left page for location.

- Internal fuse: FGMB 125 V / 5 A

■ CPU resetting

If the function display shows erroneous information when first applying power, the CPU may require resetting. CPU resetting clears all memory information.

• CPU RESET PROCEDURE:

- While pushing [MW], turn power ON.

■ CPU backup battery

The IC-820H has a lithium backup battery on the back side of the front panel for retaining memory information. The usual life of the backup battery is approximately 5 years.

CAUTION: If the lithium battery is incorrectly replaced, it could explode. Replace with a CR-2032 or equivalent type.

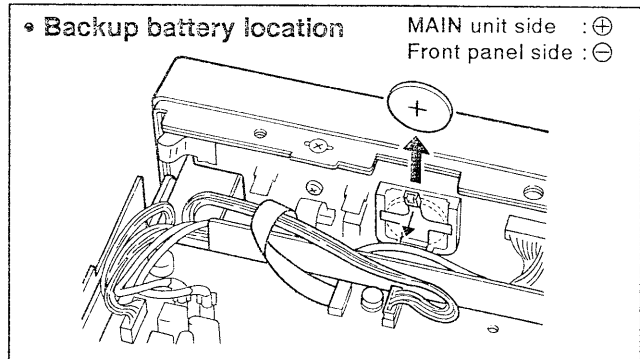

When the backup battery is exhausted, the transceiver transmits and receives normally but cannot retain memory information.

16 SPECIFICATIONS

■ GENERAL

- Frequency coverage

Version	144 MHz band	430 MHz band
U.S.A	144.0–148.0 MHz	430.0–450.0 MHz
Europe	144.0–146.0 MHz	430.0–440.0 MHz
Australia	144.0–148.0 MHz	430.0–450.0 MHz
Sweden	144.0–146.0 MHz	432.0–438.0 MHz

- Mode : SSB(A3J), CW(A1), FM(F3)
- Number of memory channels : 116
(50 regular, 1 call 2 scan edges for each band and 10 satellite memories)
- Antenna impedance : 50 Ω unbalanced
- Usable temperature range : -10°C to $+60^{\circ}\text{C}$; $+14^{\circ}\text{F}$ to $+140^{\circ}\text{F}$
- Frequency stability : ± 3 ppm (-10°C to $+60^{\circ}\text{C}$)
- Power supply requirement : 13.8 V DC $\pm 15\%$
- Current drain : Transmit High 16.0 A
Low 7.0 A
Receive Max audio 2.5 A
Stand-by 2.0 A
- Dimensions : 241(W) \times 94(H) \times 239(D) mm
9.5(W) \times 3.7(H) \times 9.4(D) in
(projections not included)
- Weight : 5.0 kg; 11.0 lb

■ TRANSMITTER

- Output power :

BAND	MODE	HIGH	LOW
144 MHz	FM, CW	45 W	6 W
	SSB	35 W	6 W
430 MHz	FM, CW	40 W	6 W
	SSB	30 W	6 W

- Spurious emissions : Less than -60 dB
- Carrier suppression : More than 40 dB
- Unwanted sideband : More than 40 dB
- Microphone impedance : 600 Ω

■ RECEIVER

- Receive system

144 MHz band

SSB, CW Single conversion superheterodyne
FM Double conversion superheterodyne

430 MHz band

SSB, CW Double conversion superheterodyne
FM Triple conversion superheterodyne

- Intermediate frequencies:

(Unit: MHz)

	MODE	MAIN BAND			SUB BAND		
		1st	2nd	3rd	1st	2nd	3rd
VHF	SSB	10.8500	—	—	10.9500	—	—
	CW	10.8491	—	—	10.9491	—	—
	FM	10.8500	0.455	—	10.9500	0.455	—
UHF	SSB	71.2500	10.8500	—	71.3500	10.9500	—
	CW	71.2491	10.8491	—	71.3491	10.9491	—
	FM	71.2500	10.8500	0.455	71.3500	10.9500	0.455

- Sensitivity (both VHF and UHF bands)

FM 0.18 μV for 12 dB SINAD
SSB, CW 0.11 μV for 10 dB S/N

- Squelch sensitivity (both VHF and UHF bands)

FM Threshold Less than 0.1 μV
Tight Less than 0.5 μV
SSB, CW Threshold Less than 1.0 μV
Tight Less than 3.2 mV

- Selectivity :

SSB, CW More than 2.3 kHz/ -6 dB
Less than 4.2 kHz/ -60 dB
CW narrow More than 0.5 kHz/ -6 dB
(optional) Less than 1.34 kHz/ -60 dB
FM More than 15.0 kHz/ -6 dB
Less than 30.0 kHz/ -60 dB

- Spurious and image : More than 60 dB rejection ratio

- Audio output power : More than 2.0 W at 10% distortion with an 8 Ω load

- RIT variable range : SSB, CW ± 2 kHz (max.)
FM ± 10 kHz (max.)

All stated specifications are subject to change without notice or obligation.

PS-55* DC POWER SUPPLY

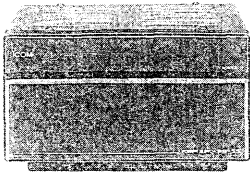

A transformer power supply. Built-in cooling fan. The size is matched with the IC-820H. Output: 13.8 V DC / 20 A

PS-30 DC POWER SUPPLY

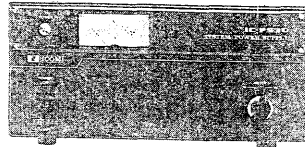

A lightweight switching regulator. System power supply with 3 output connectors. Output: 13.8 V DC / 25 A

IC-PS15* DC POWER SUPPLY

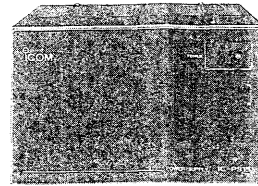

Heavy-duty power transformer system power supply. Output: 13.8 V DC / 20 A

AG-25 (144 MHz band) AG-35 (430 MHz band) PREAMPLIFIERS

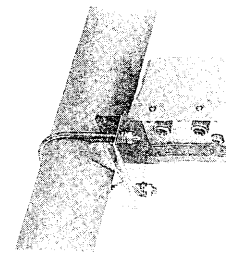

External all-weather mast-mount preamplifiers for compensating for coaxial cable loss.

SP-21 EXTERNAL SPEAKER

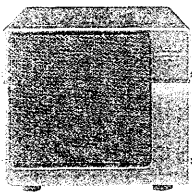

Designed for base station operation. Input: 5 W / 8 Ω

SP-20 EXTERNAL SPEAKER

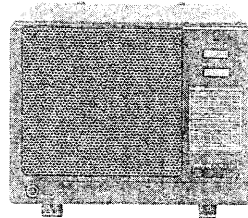

Equipped with 4 types of audio filters. 1 headphone jack and 2 selectable input connectors. Input: 5 W / 8 Ω

SP-7 EXTERNAL SPEAKER

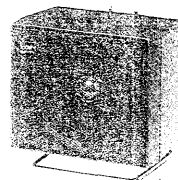

Compact speaker for base station operation. Height adjustable. Input: 5 W / 8 Ω

IC-SP3 EXTERNAL SPEAKER

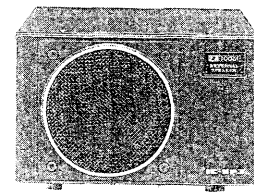

Large diameter speaker for high quality audio output. Input: 4 W / 8 Ω

SM-20 DESKTOP MICROPHONE



Unidirectional, electret condenser microphone with heavy base. Includes [UP]/[DOWN] switches and low cut function.

SM-3 DESKTOP MICROPHONE

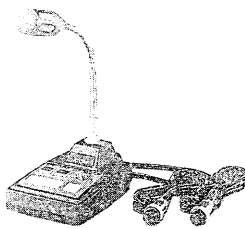

Unidirectional, electret condenser microphone with 2 connection cables / selector switch. Has [UP]/[DOWN] switch.

SM-6 DESKTOP MICROPHONE

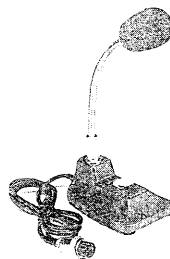

Unidirectional, electret condenser microphone for desktop operation.

HM-12, HM-14 HAND MICROPHONE

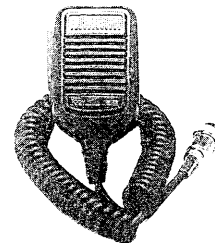

Hand microphone equipped with the [UP]/[DOWN] switches. The HM-14 has DTMF keypad.

CT-17 CI-V LEVEL CONVERTER

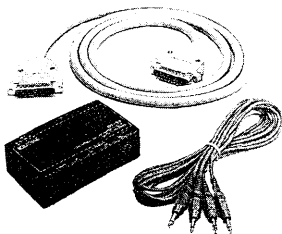

Level converter to connect the transceiver to an RS-232C port of a computer for remote control.

MB-23 CARRYING HANDLE



Carrying handle for easy portable operation. Use screws included with the transceiver.

IC-MB5 MOBILE MOUNTING BRACKET



Mounting bracket for installing the transceiver in your vehicle, boat, etc.

CR-293 HIGH-STABILITY CRYSTAL UNIT

Frequency stability: ± 0.5 ppm

FL-132 CW NARROW FILTER

500 Hz / -6 dB 1.34 kHz / -60 dB

UT-36 VOICE SYNTHESIZER UNIT

Announces freq., mode, and memory channel number.

UT-50 TONE SQUELCH UNIT

Provides a "personalized" tone squelch system.

* The PS-55 and IC-PS15 cannot be used with the Europe and Sweden versions.

Count on us!